

# PIC

SWITCHING THE SMART WAY

## SENSOR TECHNOLOGY

Reed Switches

SMD Reed Switches

Reed Sensors

Hall Sensors

TMR Sensors

Magnets

Level Sensors

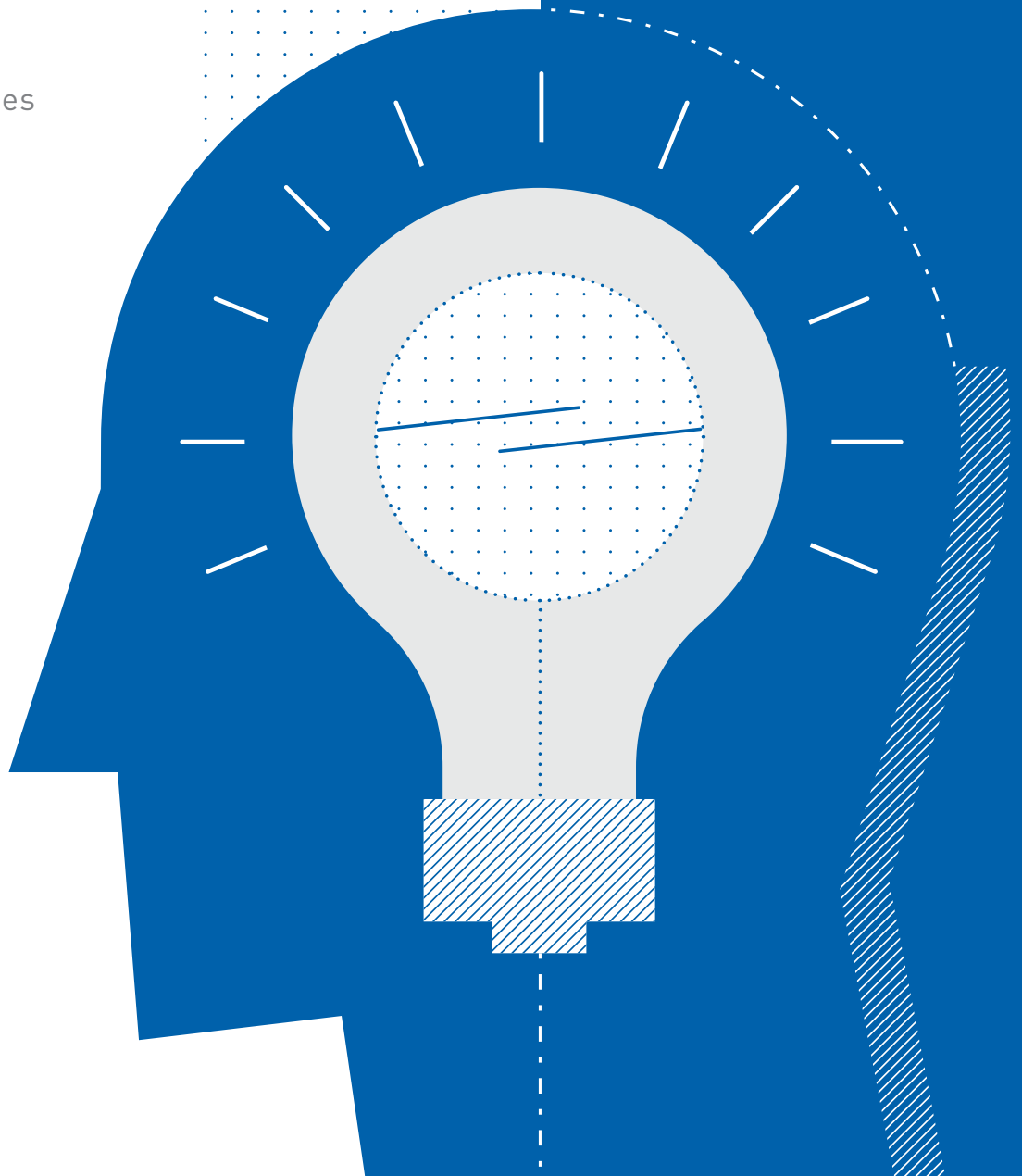

## Progress through dynamics

Our work is never done. **Passion, respect, integrity and discipline** are the four core values which drive us to sophisticated products and continuous growth in a globalized world.

**For more than 40 years** we have been dealing with Reed Switches, Magnets and the manufacturing of high quality **customized sensor solutions** based on Reed- and Hall-Technology.

More than 300 employees – all of them **experts in their special trade** – are working in our headquarters in Germany, sales offices in Asia and Europe and our two own production facilities in China and Turkey.

With these three factors: people, knowledge and own manufacturing we make sure to be **your reliable partner for Sensor Technology** – today and tomorrow!

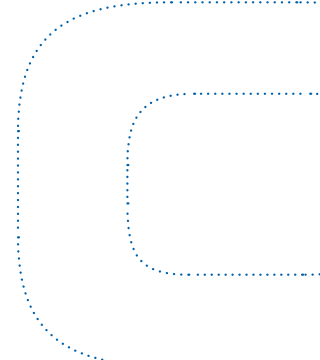
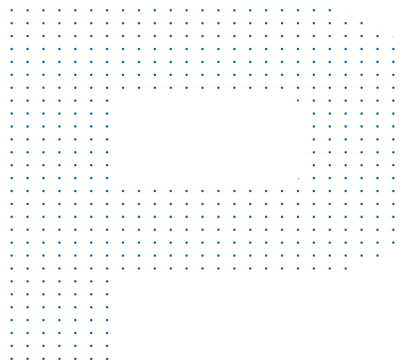

## Innovation

Modern machinery, perfected production concepts, clear information policy and our comprehensive sensor know-how secure our premier position in the industry.

## Quality

Continuous optimization in the areas of research, development, production, service and marketing assure high standards in product quality.

## Sustainability

Sustainability is an essential part of our philosophy. Careful use of resources and environmental compatibility starts long before production and does not finish at sale. We remain true to this principle with regard to social and economic aspects.

■ PIC GROUP

■ PIC PARTNER NETWORK

/// PIC DIRECT SALES

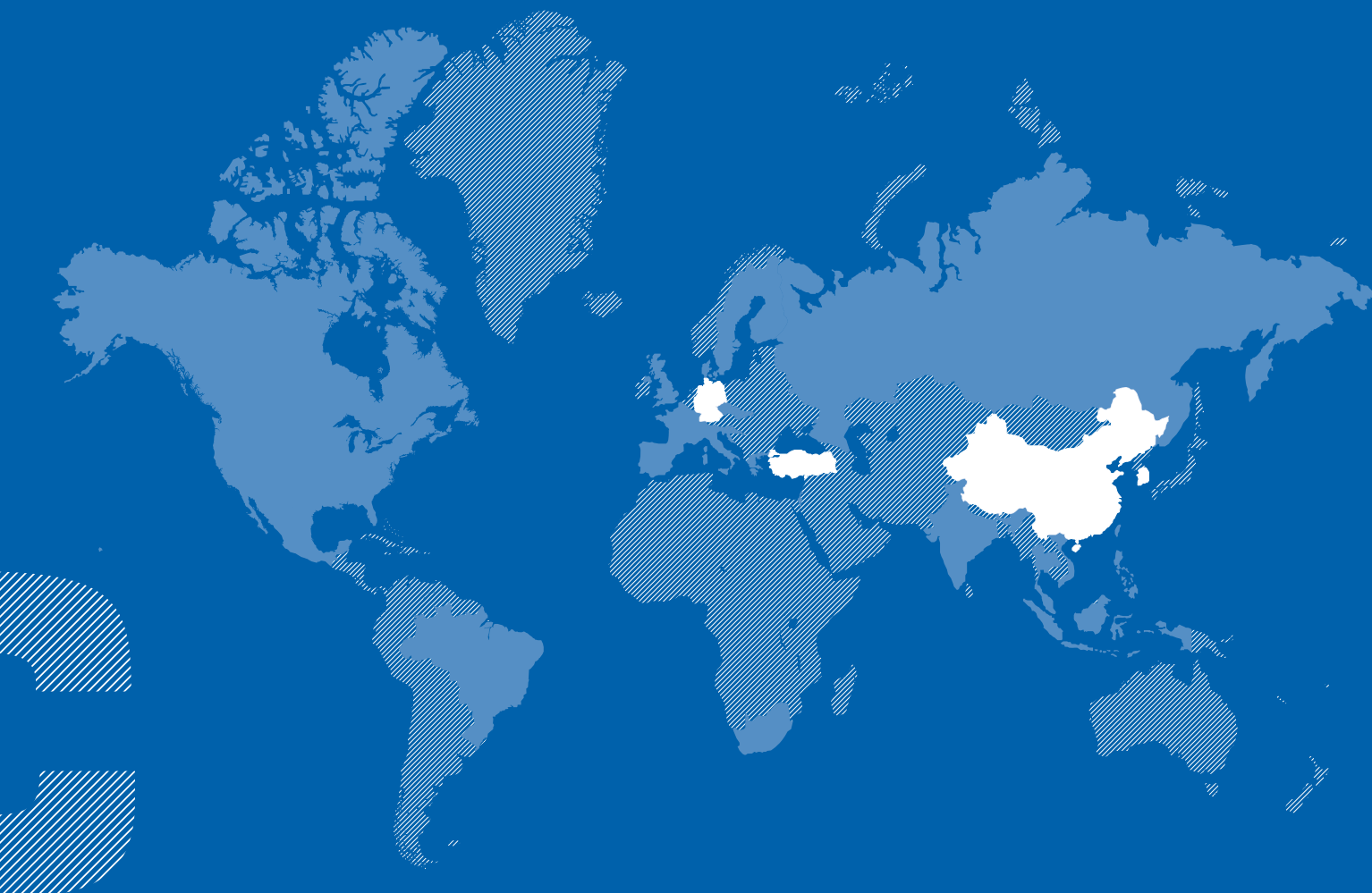

## Contact

*[A connection between people and companies, the possibility to exchange information in writing, verbally or personally.]*

### **PIC GmbH**

Wendelstein, Germany  
Phone: +49 (0) 9129 90 70 89-0  
E-Mail: [info@pic-gmbh.com](mailto:info@pic-gmbh.com)

### **PIC Sensors Asia Ltd.**

Hong Kong  
Phone: +852 27 82 27 83  
E-Mail: [hongkong@pic-gmbh.com](mailto:hongkong@pic-gmbh.com)

### **PIC Sensors Korea Inc.**

Seoul, South Korea  
Phone: +82 31 717 55 74  
E-Mail: [korea@pic-gmbh.com](mailto:korea@pic-gmbh.com)

### **PIC Sensors Zhuhai Ltd.**

Zhuhai, P.R.China  
Phone: +86 756 7512130  
E-Mail: [china@pic-gmbh.com](mailto:china@pic-gmbh.com)

### **PIC Sensor San. ve Tic. Ltd. Sti.**

Gebze / Kocaeli, Turkey  
Phone: +90 262 751 17 16  
E-Mail: [turkey@pic-sensor.com.tr](mailto:turkey@pic-sensor.com.tr)

# Table of Contents

**Contact** ..... 3

## Reed Switches and SMD Reed Switches

Basics ..... 6

**Reed Switches**

Micro/Standard ..... 7

Power/Special ..... 8

**SMD Reed Switches**

F-Series ..... 10

S-Series ..... 11

T-Series ..... 12

Z-Series ..... 13

FH-Series ..... 14

TH-Series ..... 15

Reed Chains..... 16

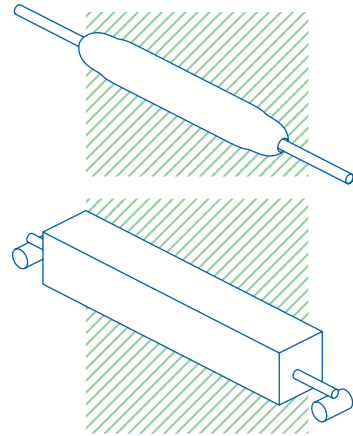

## Sensors

### Reed Sensors

Basics ..... 18

Flatpack ..... 19

Through Hole ..... 21

Tubular ..... 22

Tubular Threaded ..... 23

Press-fit ..... 25

Snap-fit ..... 26

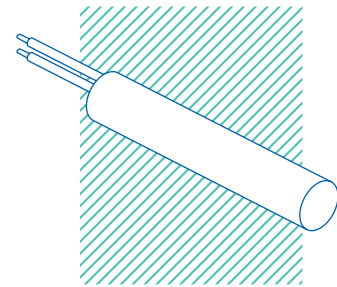

### Hall & TMR Sensors

Basics ..... 28

Hall Flatpack ..... 29

Hall Tubular Threaded ..... 30

Hall Flange Mount ..... 31

TMR Flatpack ..... 32

TMR Tubular Threaded ..... 33

TMR Flange Mount ..... 34

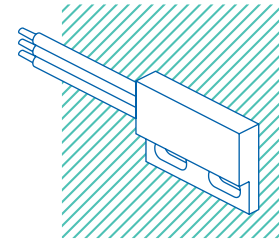

## Magnets

Basics ..... 36

Magnet Selector ..... 37

Actuators ..... 38

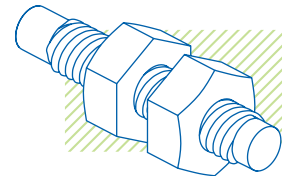

## Level Sensors

Basics ..... 41

PLS-PP-Series ..... 42

PLS-PA-Series ..... 44

PLS-VA-Series ..... 45

PLS-PP Horizontal ..... 46

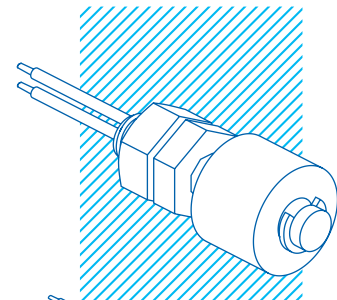

## Floats

Actuators ..... 47

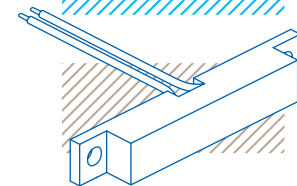

## Customized Products

Basics ..... 49

Examples ..... 50

## Tech Center

Reed Switches: How to operate ..... 52

Reed Switches: Precautions ..... 53

Housing Materials: Chemical resistance chart ..... 54

Industries and Applications ..... 55

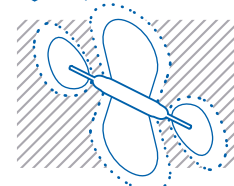

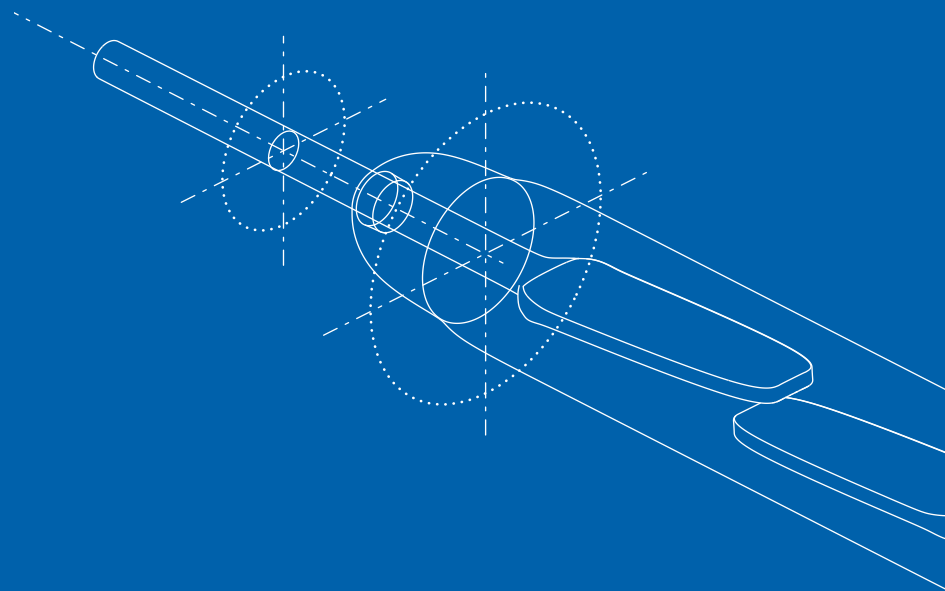
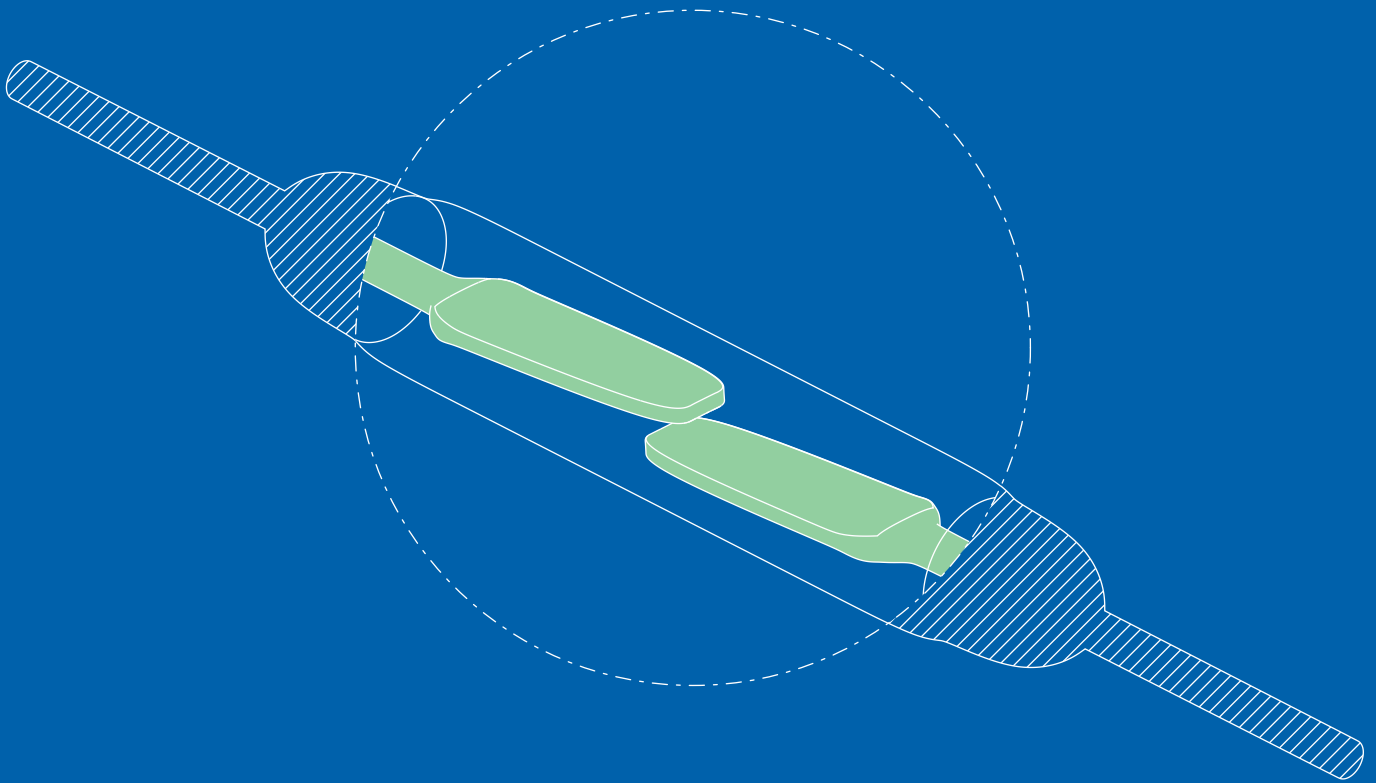

## Reed Switches

*[Also known as Reed Contacts or Magnetic Contacts. Electromechanical, hermetically sealed components which close or open a circuit through actuation by a magnetic field.]*

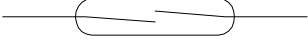

## Different forms

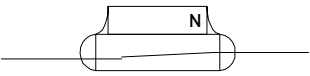
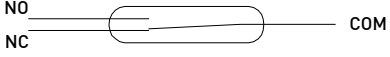
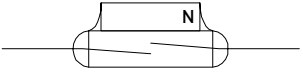
- A**  **Form A**  
Normally Open. Reed Switch will close contact in presence of a magnet.
- B1**  **Form B**  
Normally Closed. Either achieved by using a Form C switch with the NO wire cut off or by using an attached magnet (requires pole oriented actuation).
- B2** 
- C**  **Form C**  
Change Over. Reed Switch will change from NC to NO contact in presence of a magnet.
- E**  **Form E**  
Latching Type. Switching status remains stable after a magnetic field disappears until a magnet with opposite polarity approaches.

## How does a Reed Switch work?

A Reed Switch consists of a pair of ferromagnetic reeds, hermetically sealed in a glass tube. Their free ends overlap at a very small distance.

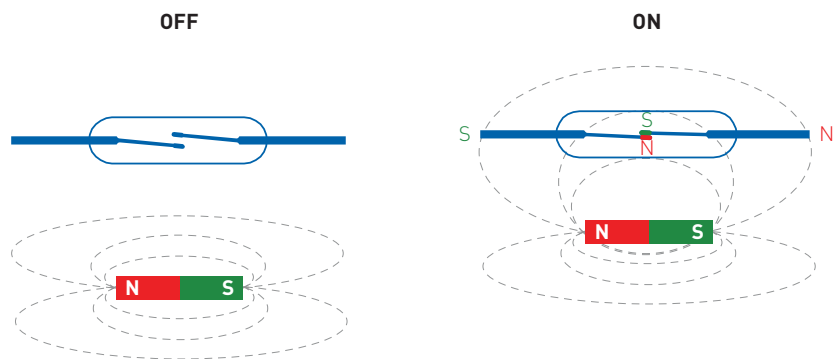

## Benefits

- /// No power supply required
- /// Contacts hermetically sealed
- /// Most economic non-touch switching solution
- /// Not ESD sensitive
- /// Various methods of actuation possible
- /// Magnetic and electrical pole independent
- /// Non-touch actuation permits smooth surfaces and modern design
- /// Various sensitivity ranges available

## Features

PMC-0701 for limited space the 7 mm glass length offers best solution

PMC-1401 most cost-efficient general purpose switch using 14 mm glass length

Close differential and mains voltage types available

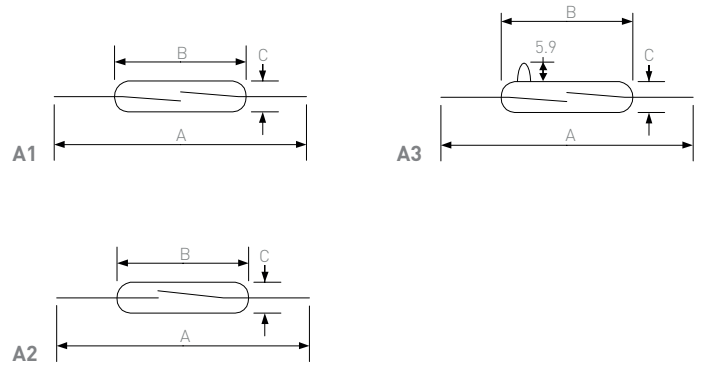
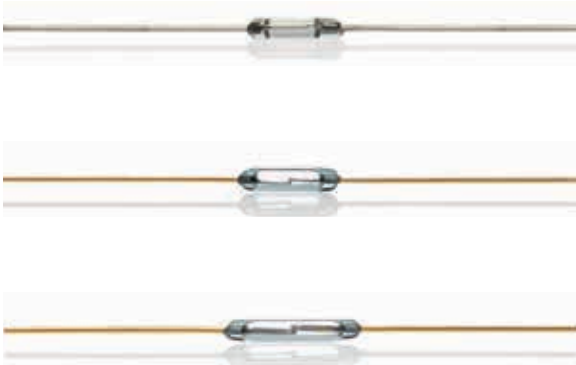

		Micro Switches				Standard Switches								
		HSR-0025	HSR-0035RT	PMC-0701	HSR-502	PMC-0822	PMC-1001	PMC-1401	PMC-1406 DO min. 60%!	PMC-2003 DO max. 60%!	PMC-1515 Mains voltage	PMC-1496	TRH-200	
<b>Dimensions</b>														
A = Total Length (nom.)	mm	26.7	26.7	41.5	37.9	51.0	41.5	44.0	44.0	45.6	40.4	55.0	52.5	
B = Glass Length (max.)	mm	4.32	5.08	7.0	8.0	9.6	10.0	14.2	14.2	21.0	15.3	14.5	14.8	
C = Glass Diameter (max.)	mm	0.97×1.27	1.4	1.8	2.2	2.2	1.8	2.3	2.3	3.0	2.3	2.2	2.7	
Contact Arrangement (figure)		A2	A2	A1	C2	C2	A1	A1	A1	A1	A1	C2	C2	
<b>Characteristics</b>														
Contact Form		A	A	A	C	C	A	A	A	A	A	C	C	
Contact Rating (max.)	W/VA	0.25	1	10	2	3	10	10	7	10	10	20	5	
Switching Voltage (max.)	VDC	30	30	150	30	50	180	200	200	180	200	150	175	
	VAC	20	30	120	30	50	130	140	140	130	260	140	120	
Switching Current (max.)	A	0.01	0.05	0.5	0.1	0.2	0.7	1	0.5	1	0.3	1	0.25	
Carry Current (max.)	A	0.7	1	0.7	1	0.5	1	1.2	1.0	2	1.4	2	1.5	
Breakdown Voltage (min.)	VDC	80	200	200	200	100	200	240	240	250	400	200	200	
Contact Resistance (max.) (initial)	mΩ	750	750	200	300	150	150	100	100	150	100	150	100	
Pull in range available	AT	4-15	5-20	5-20	15-35	15-25	5-25	5-30	8-20	30-50	20-30	15-30	15-30	
Drop out (min.)	AT	1	3	4	5	5	4	4	4	45-60% of PI	4	6	5	
Switching Frequency (max.)	Hz	900	700	600	100	100	500	500	500	400	400	100	100	
Vibration (50-2000 Hz)	g	15	15	10	30	30	20	20	20	20	30	30	30	
Shock (1/2 sin 11 ms)	g	75	75	50	50	100	100	100	100	50	100	50	50	
Operating Temperature	°C	-40 to +125				-40 to +130	-40 to +130	-60 to +155	-60 to +155	-40 to +125	-20 to +125	-40 to +130	-40 to +125	
UL/CSA/RoHS		--/--/•	--/--/•	•/•/•	--/--/•	--/--/•	•/•/•	•/•/•	•/•/•	--/--/•	--/--/•	--/--/•	--/--/•	

AT ranges and characteristics stated for unmodified Reed Switches. Pls. refer page 52-53 for additional technical information. All dimensions in mm. Subject to change without prior notice.

## Features

Switching Voltage up to 6 kV

Carry Current up to 5 A

Contact Rating max. 250 Watts

Normally Open, change over and latching types

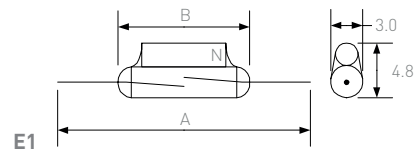
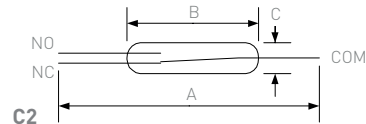
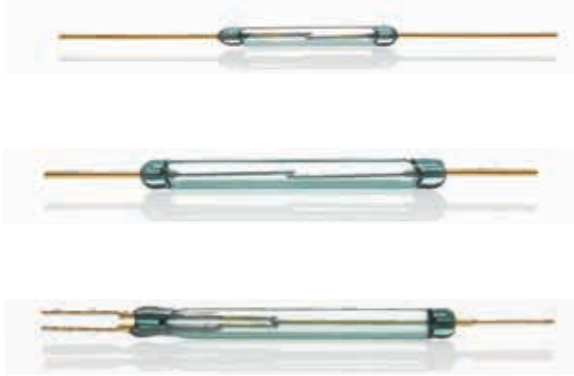

	Power Switches							Special Switches			
	PMC-2021	PMC-3617	PMC-5001	PMC-5002	PMC-5025	HSR-834WT	High voltage		Latching		
							HSR-910W-V8K	HSR-910W-V11K	HSR-910W-V15K	PMC-1401X	
<b>Dimensions</b>											
A = Total Length (nom.)	mm	55.0	70.0	80.0	80.0	80.0	86.0	82.0	82.0	82.0	44.0
B = Glass Length (max.)	mm	20.0	36.0	50.0	50.0	52.0	34.3	52.0	52.0	52.0	14.2
C = Glass Diameter (max.)	mm	2.54	5.6	5.4	5.4	5.6	5.33	5.4	5.4	5.4	
Contact Arrangement (figure)		A1	C2	A1	A1	C2	C2	A3	A3	A3	E1
<b>Characteristics</b>											
Contact Form		A	C	A	A	C	C	A	A	A	E
Contact Rating (max.)	W/VA	50	60	120	250	60	100	100	100	100	5
Switching Voltage (max.)	VDC	200	400	250	250	230	240	5000	6500	7000	140
	VAC	250	400	250	250	230	240	3500	4500	4900	100
Switching Current (max.)	A	1.5	1	3	5	1	4	3	3	3	0.5
Carry Current (max.)	A	2	2	3	5	2	4	3.5	3.5	3.5	0.7
Breakdown Voltage (min.)	VDC	400	1000	700	700	400	1000	8000	11000	15000	200
Contact Resistance (max.) (initial)	mΩ	100	100	200	200	100	500	150	150	150	150
<b>Performance</b>											
Pull in range available	AT	25-40	50-80	50-90	50-100	80-120	60-100	80-110	110-140	140-170	
Drop out min.	AT	5	20	20	15	20	30	20	20	20	
<b>Switching and Vibration</b>											
Switching Frequency (max.)	Hz	300	100	25	25	100	50	50	50	50	500
Vibration (50-2000 Hz)	g	20	35 <sup>1)</sup>	10 <sup>2)</sup>	10 <sup>2)</sup>	35 <sup>1)</sup>	15	30	30	30	10
Shock (1/2 sin 11 ms)	g	50	50	150 <sup>3)</sup>	150 <sup>3)</sup>	50	10	100	100	100	50
Operating Temperature	°C	-60 to +125	-40 to +125	-60 to +130	-60 to +100	-40 to +125	-25 to +125	-60 to +150			-40 to +125
UL/CSA/RoHS		•/•/•	--/--/•	•/•/•	•/•/•	--/--/•	•/•/•	--/--/•	--/--/•	--/--/•	--/--/•

<sup>1)</sup> 10-2000Hz <sup>2)</sup> 1-500Hz <sup>3)</sup> 1/2 sin 2ms

AT ranges and characteristics stated for unmodified Reed Switches. Pls. refer page 52-53 for additional technical information. All dimensions in mm. Subject to change without prior notice.



## SMD Reed Switches

*[Modified Reed Switches with or without housing, suitable for automated production processes (SMT Technology) and therefore shipped in Tape&Reel-Packaging.]*

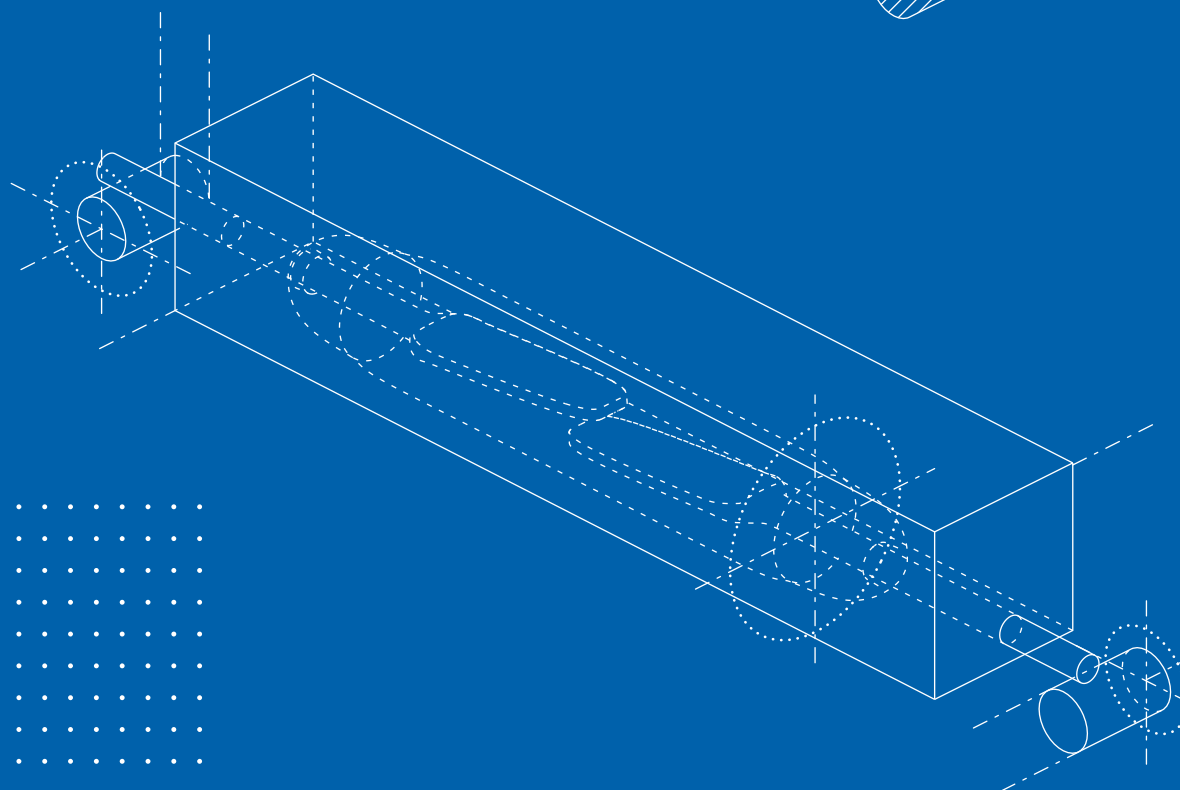
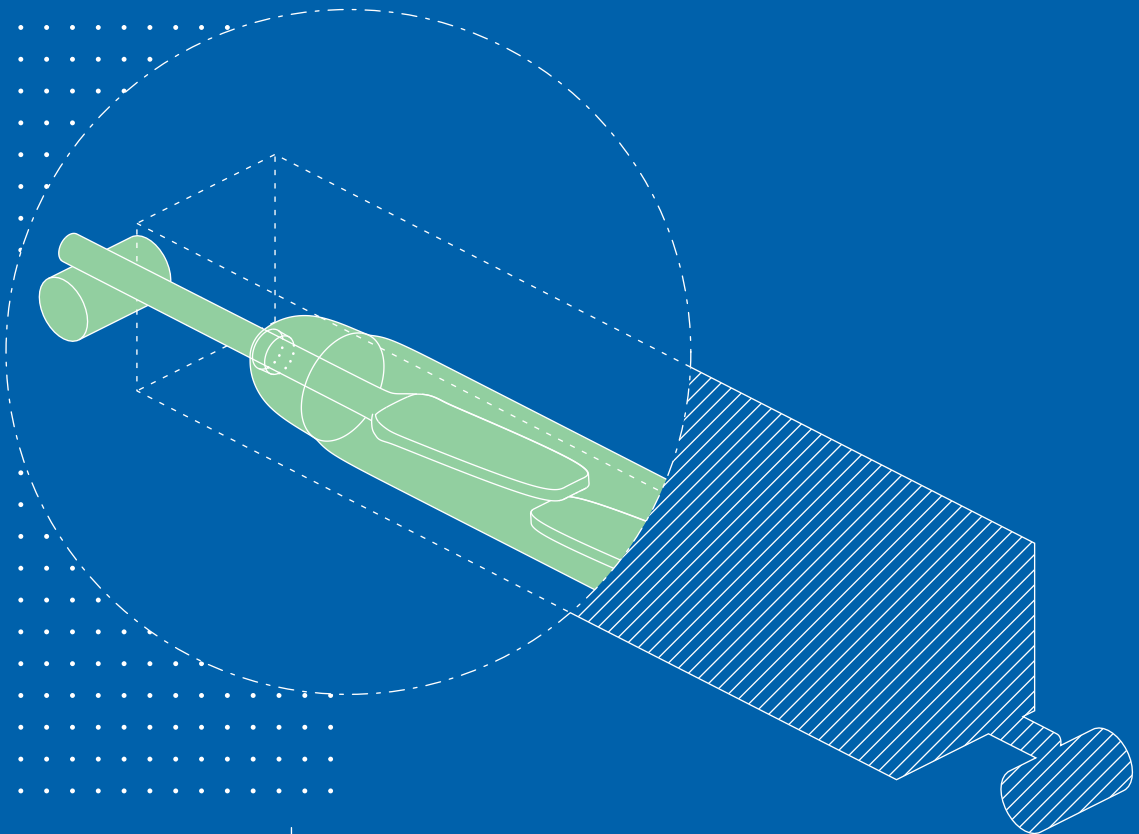

F-Series

Features

- Replaces various competitors types
- Suitable for automated assembly
- Tape&Reel Packaging



PMC-0701F

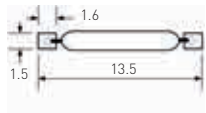
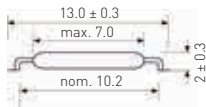

PMC-1001F

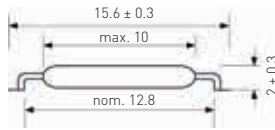

Recommended pad size

		PMC-0701F	PMC-1001F
Contact Form		A	A
Contact Rating (max.)	W/VA	10	10
Switching Current (max.)	A	0.5	0.7
Switching Voltage (max.)	VDC	150	180
	VAC	120	130
Pull in range available	AT	10-20	10-25
Operating Temperature	°C	-40 to +125	-40 to +125
UL/CSA/RoHS		--/--/•	--/--/•
Packaging Unit	pcs.	2500	2500

AT ranges and characteristics stated for unmodified Reed Switches. Pls. refer page 52-53 for additional technical information. All dimensions in mm. Subject to change without prior notice.

S-Series

Features

- Most economic Reed Switch for automated assembly
- Assembly in cutout reduces height above PCB by approx. 50%
- Various sensitivity ranges and total lengths variants



PMC-0701S

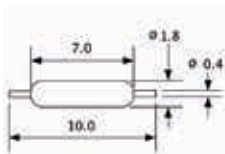

PMC-1001S

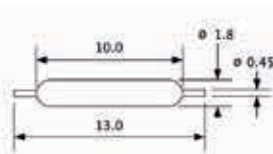

PMC-1401S



PMC-2021S

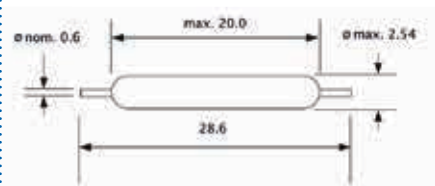

PCB cutout

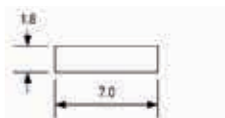

Recommended pad size

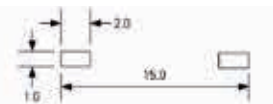
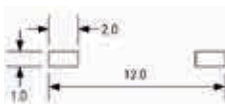

		PMC-0701S	PMC-1001S	PMC-1401S	PMC-2021S
Contact Form		A	A	A	A
Contact Rating (max.)	W/VA	10	10	10	50
Switching Current (max.)	A	0.5	0.7	1	1.5
Switching Voltage (max.)	VDC	150	180	200	200
	VAC	120	130	140	250
Pull in range available	AT	10-20	10-25	10-25	25-40
Operating Temperature	°C	-40 to +125	-40 to +125	-60 to +155	-60 to +125
UL/CSA/RoHS		•/•/•	•/•/•	•/•/•	•/•/•
Packaging Unit	pcs.	3000	3000	5000	2500

AT ranges and characteristics stated for unmodified Reed Switches. Pls. refer page 52-53 for additional technical information. All dimensions in mm. Subject to change without prior notice.

T-Series

Features

- Attractively priced alternative to molded Reed Switches
- Replaces various molded competitors types, thus no PCB redesign required
- Various sensitivity ranges available



HSR-0025TSM

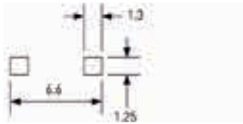
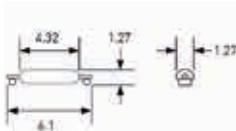

PMC-0701TS

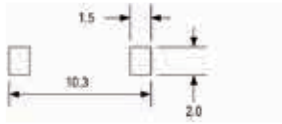
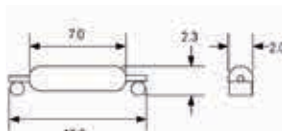

PMC-1001TS

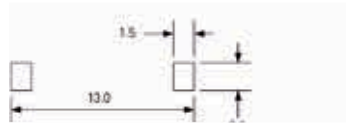
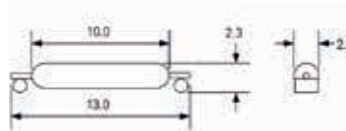

PMC-1001T

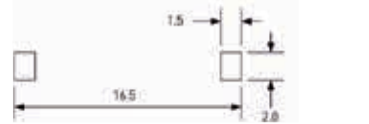
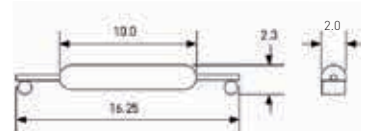

PMC-1401TS

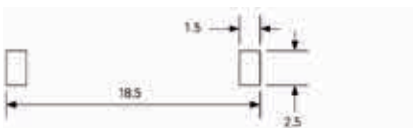
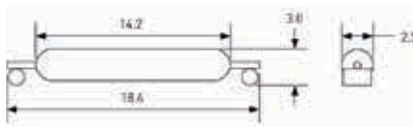

PMC-1401T

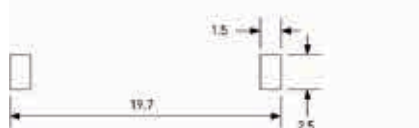
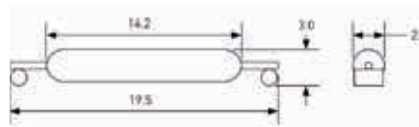

PMC-2021T



		HSR-0025TSM	PMC-0701TS	PMC-1001T/TS	PMC-1401T/TS	PMC-2021T
Contact Form		A	A	A	A	A
Contact Rating (max.)	W/VA	0.25	10	10	10	50
Switching Current (max.)	A	0.01	0.5	0.7	1	1.5
Switching Voltage (max.)	VDC	30	150	180	200	200
	VAC	20	120	130	140	250
Pull in range available	AT	5-15	10-20	10-25	10-25	25-40
Operating Temperature	°C	-40 to +125	-40 to +125	-40 to +125	-60 to +155	-60 to +125
UL/CSA/RoHS		--/--/•	•/•/•	•/•/•	•/•/•	•/•/•
Packaging Unit	pcs.	200	5000	5000	2500	2500

AT ranges and characteristics stated for unmodified Reed Switches. Pls. refer page 52-53 for additional technical information. All dimensions in mm. Subject to change without prior notice.

### Features

- Designed to lay in PCB cut out
- Smallest height over PCB with only 0.45 mm for PMC-0701Z
- Improved mechanical protection for glass body



PMC-0701Z

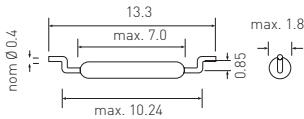

PMC-1001Z

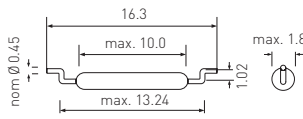

PMC-1401Z

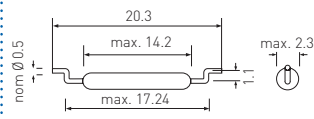

PMC-2021Z

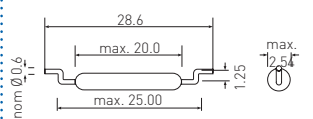

PCB cutout  
Recommended pad size

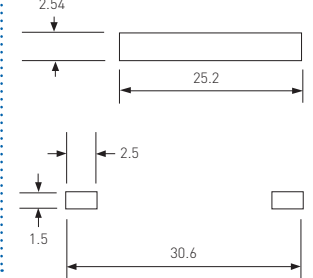
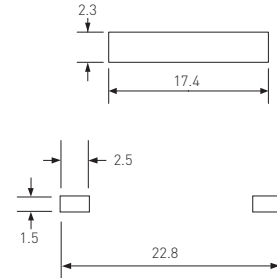
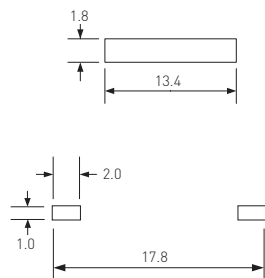
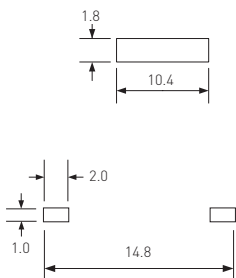

PMC-1001ZHL

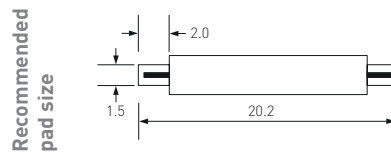
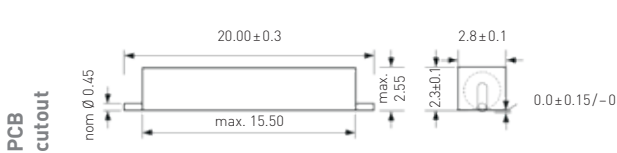

		PMC-0701Z	PMC-1001Z	PMC-1401Z	PMC-2021Z	PMC-1001ZHL
Contact Form		A	A	A	A	A
Contact Rating (max.)	W/VA	10	10	10	50	10
Switching Current (max.)	A	0.5	0.7	1	1.5	0.7
Switching Voltage (max.)	VDC	150	180	200	200	180
	VAC	120	130	140	250	130
Pull in range available	AT	10-20	10-25	10-25	25-40	10-25
Operating Temperature	°C	-40 to +125	-40 to +125	-60 to +155	-60 to +125	-40 to +125
UL/CSA/RoHS		•/•/•	•/•/•	•/•/•	•/•/•	--/--/•
Packaging Unit	pcs.	5000	5000	5000	2500	2500

AT ranges and characteristics stated for unmodified Reed Switches. Pls. refer page 52-53 for additional technical information. All dimensions in mm. Subject to change without notice.

## FH-Series

## Features

Tape &amp; Reel Packaging

Suitable for automated assembly

Not ESD sensitive

Perfect economical alternative to Hall Switches



PMC-0701FH

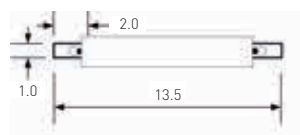
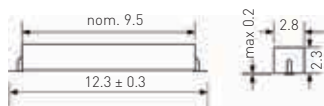

PMC-1001FH

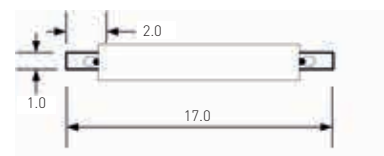
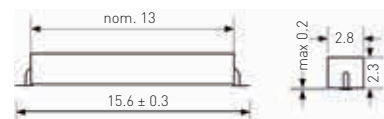

Recommended pad size

		PMC-0701FH	PMC-1001FH
Contact Form		A	A
Contact Rating (max.)	W/VA	10	10
Switching Current (max.)	A	0.5	0.7
Switching Voltage (max.)	VDC	150	180
	VAC	120	130
Pull in range available	AT	10-20	10-25
Operating Temperature	°C	-40 to +125	-40 to +125
UL/CSA/RoHS		--/--/•	--/--/•
Packaging Unit	pcs.	2500	2500

AT ranges and characteristics stated for unmodified Reed Switches. Pls. refer page 52-53 for additional technical information. All dimensions in mm. Subject to change without prior notice.

**Features**

- Replaces various molded competitors types, thus no PCB redesign required
- Latching and Form B (normally closed) types available
- Various sensitivity ranges available



PMC-0508TH

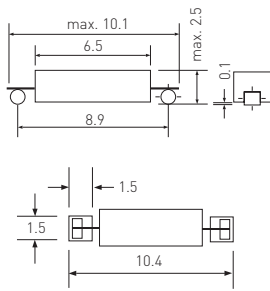

Recommended pad size

PMC-0701TH

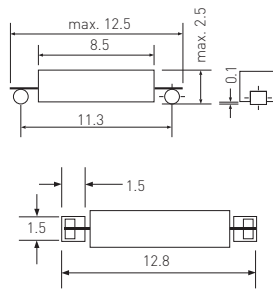

PMC-1001TH

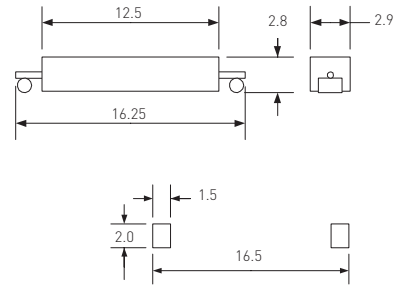

PMC-1001THL

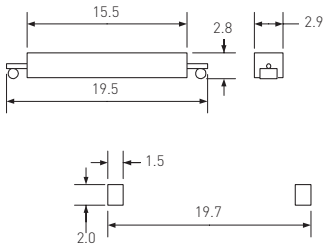

Recommended pad size

PMC-1001THY

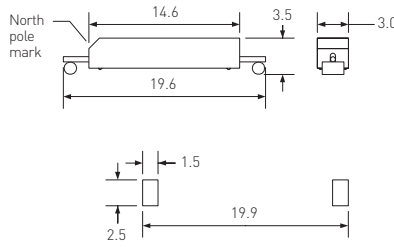

PMC1401THX

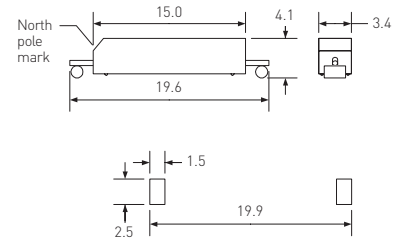

		PMC-0508TH	PMC-0701TH	PMC-1001TH PMC-1001THL	Normally Closed PMC-1001THY	Latching PMC1401THX
Contact Form		A	A	A	B	E
Contact Rating (max.)	W/VA	5	10	10	10	5
Switching Current (max.)	A	0.25	0.5	0.7	0.7	0.5
Switching Voltage (max.).	VDC	175	150	180	180	140
	VAC	140	120	130	130	100
Pull in range available	AT	5-15	10-20	10-25	11-13	consult factory
Operating Temperature	°C	-40 to +125	-40 to +125	-40 to +125	-40 to +125	-20 to +125
UL/CSA/RoHS		--/--/•	•/•/•	•/•/•	•/•/•	•/•/•
Packaging Unit	pcs.	2500	2500	2500	2000	2000

AT ranges and characteristics stated for unmodified Reed Switches. Pls. refer page 52-53 for additional technical information. All dimensions in mm. Subject to change without prior notice.

# Reed Chains

## Features

Reliable signals

Individual level sensing

Build own solutions based on high quality switching elements

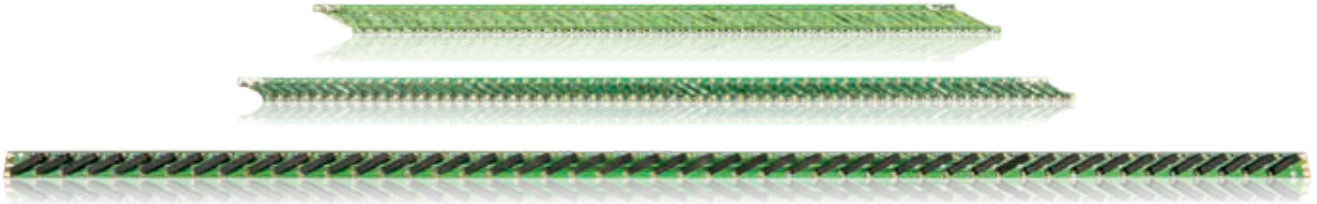

LP-XX01S25

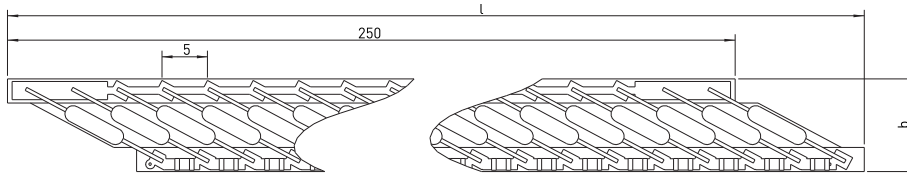

LP-XX01TS25

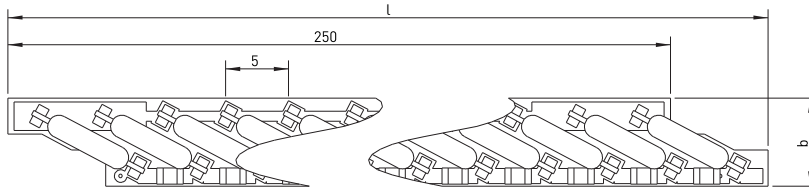

LP-1001TH50

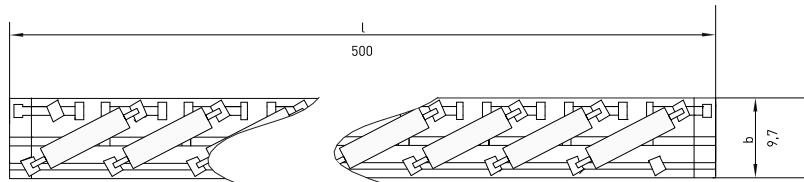

		LP-0701S	LP-1001S	LP-1401S	LP-0701TS	LP-1001TS	LP-1401TS	LP-1001TH
Contact Rating (max.)	W	10	10	10	10	10	10	10
Switching Current (max.)	A	0.5	0.7	1	0.5	0.7	1	0.7
Switching Voltage (max.)	VDC	150	180	200	150	180	200	180
	VAC	120	130	140	120	130	140	130
Width b	mm	10.2	11.6	13.9	7	8.4	11.3	9.7
Length l	mm	264.2	266.8	271.2	257.8	260.4	265	500
Resistance	kOhm	1	1	1	1	1	1	0.5
UL/CSA/RoHS		--/--/•	--/--/•	--/--/•	--/--/•	--/--/•	--/--/•	--/--/•

Individual variations with more/fewer switching points, different resistance values and matching Floats are available - please contact us!



## Reed Sensors

*[Reed Switches with housing; simplified assembly, improved mechanical protection; actuation similar to a Reed Switch; existing in various forms (with cable / with connector / THT versions).]*

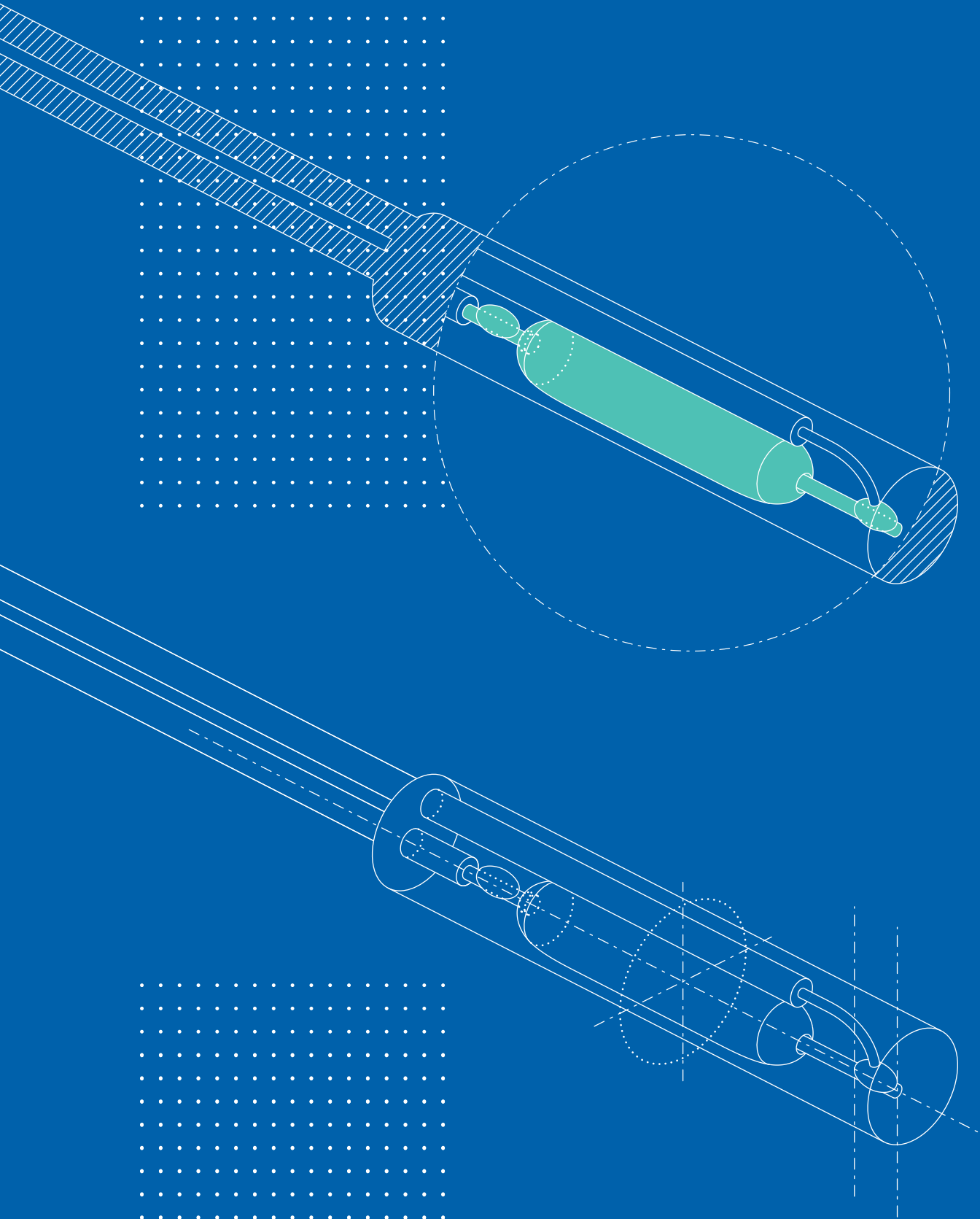

## How does a Reed Sensor work?



A Reed Sensor incorporates a Reed Switch inside a metal or plastic housing for better mechanical protection and easier mounting. Actuation principles for Reed Switches also apply to Reed Sensors.

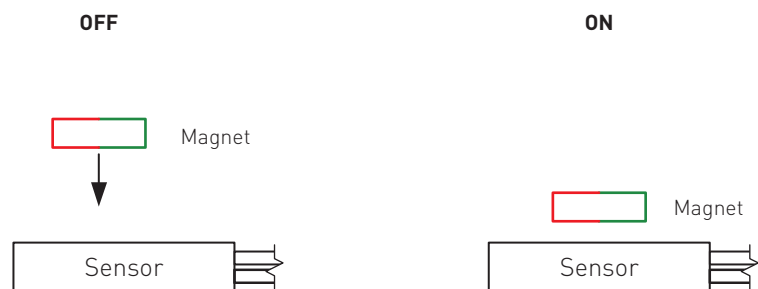

### Benefits

- /// Mechanically protected
- /// Wide range of housing types available
- /// No power supply required
- /// All Reed Sensors IP67 rated
- /// Not ESD sensitive
- /// Non-touch actuation permits smooth surfaces and modern design
- /// Various sensitivity ranges available

### Features

- Adjustable switching point
- Replaces various competitors types
- Mains voltage variants available
- Various sensitivity ranges available
- Customized types available



#### Standard Types

##### MS-313-3

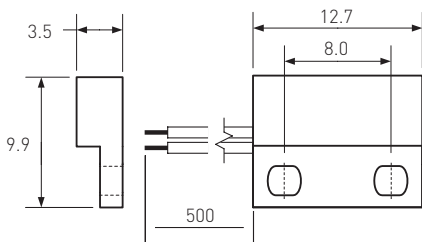

##### MS-324

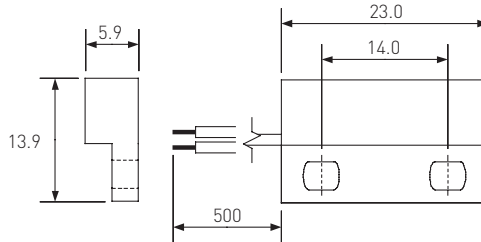

#### Cable exit:

##### MS-313R

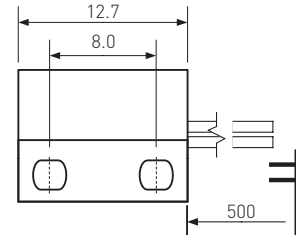

##### MS-324R

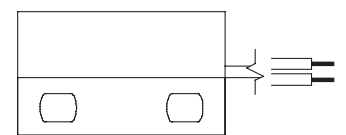

		MS-313-3	MS-324-3	MS-324-4	MS-324-5	MS-324-7
Contact Form		A	A	C	A	B
Contact Rating (max.)	W/VA	10	10	5	10	5
Switching Current (max.)	A	0.5	1	0.25	0.3	0.25
Switching Voltage (max.)	VDC	150	200	175	200	175
	VAC	120	140	120	260	120
Pull in range available	AT	10-20	10-25	15-30	15-30	15-30
Operating Temperature	°C	-20 to +85	-20 to +85	-20 to +85	-20 to +85	-20 to +85
UL/CSA/RoHS		--/--/•	•/•/•	•/•/•	•/•/•	•/--/•
Housing Material		ABS	ABS	ABS	ABS	ABS
Cable Type		AWG 26	AWG 24	AWG 26	AWG 24	AWG 24

AT ranges and characteristics stated for unmodified Reed Switches. Pls. refer page 52-54 for additional technical information. All dimensions in mm. Subject to change without prior notice.

## Flatpack

### Features

- Adjustable switching point
- Replaces various competitors types
- Mains voltage variants available
- Various sensitivity ranges available
- Customized types available



#### Standard Types

##### MS-328

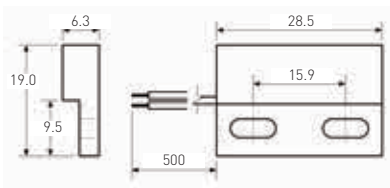

##### MS-332

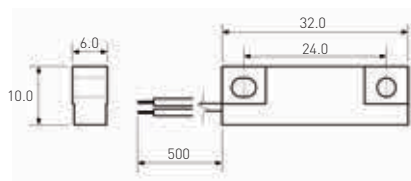

#### Cable exit:

##### MS-332R

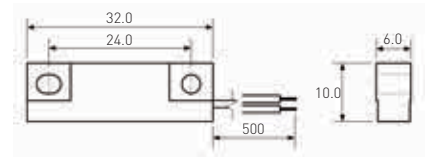

		MS-328-3 MS-332-3	MS-328-4	MS-328-5 MS-332-5	MS-328-6 MS-332-6	MS-328-7 MS-332-7
Contact Form		A	C	A	A	B
Contact Rating (max.)	W/VA	10	5	10	50	5
Switching Current (max.)	A	1	0.25	0.3	1.5	0.25
Switching Voltage (max.)	VDC	200	175	200	200	175
	VAC	140	120	260	250	120
Pull in range available	AT	10–25	15–30	15–30	25–40	15–30
Operating Temperature	°C	–20 to +85	–20 to +85	–20 to +85	–20 to +85	–20 to +85
UL/CSA/RoHS*		•/•/•	•/•/•	•/•/•	•/•/•	•/•/•
Housing Material		PA-GF ABS	PA-GF	PA-GF ABS	PA-GF ABS	PA-GF ABS
Cable Type		AWG 20	AWG 22	AWG 24	AWG 24	AWG 24

Matching actuators on page 38.

AT ranges and characteristics stated for unmodified Reed Switches. Pls. refer page 52–54 for additional technical information. All dimensions in mm. Subject to change without prior notice.

\*MS-332-7 only RoHS

### Features

- /// Pitch ranging from 2.54 to 20.32 mm
- /// Mechanically protected
- /// Replaces various competitors types
- /// Mains voltage variants available
- /// Customized types available



MS-104

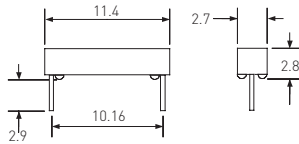

MS-105

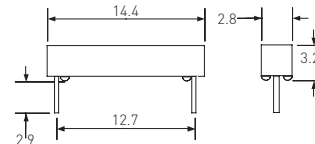

MS-106

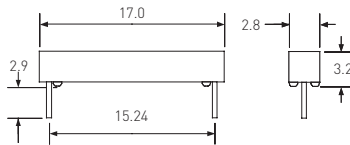

MS-107

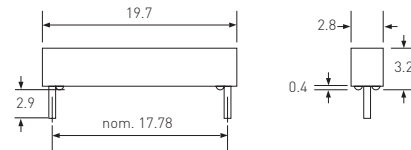

MS-108

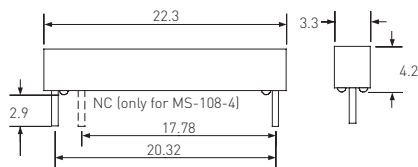

MS-110X

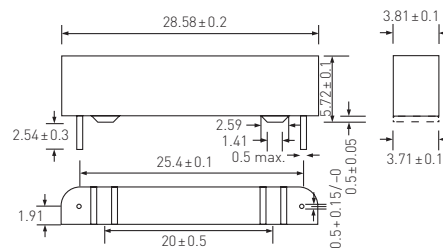

		MS-104 MS-105	MS-106	MS-107	MS-108-3	MS-108-4	MS-108-5	MS-110X
Contact Form		A	A	A	A	C	A	E
Contact Rating (max.)	W/VA	10	10	10	10	5	10	5
Switching Current (max.)	A	0.5	0.7	0.7	1	0.25	0.3	0.5
Switching Voltage (max.)	VDC	150	180	180	200	175	200	140
	VAC	120	130	130	140	120	260	100
Pull in range available	AT	10-20	10-25	10-25	10-25	15-30	15-30	consult factory
Operating Temperature	°C	-20 to +85	-20 to +85	-20 to +85	-20 to +85	-20 to +85	-20 to +85	-20 to +85
UL/CSA/RoHS		•/•/•	•/•/•	--/--/•	•/•/•	•/•/•	•/•/•	--/--/•

AT ranges and characteristics stated for unmodified Reed Switches. Pls. refer page 52-54 for additional technical information. All dimensions in mm. Subject to change without prior notice.

Tubular

Features

Replaces various competitors types

Mains voltage variants available

Various sensitivity ranges available

Customized types available



MS-208

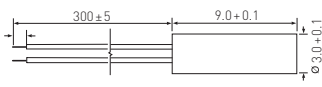

MS-209

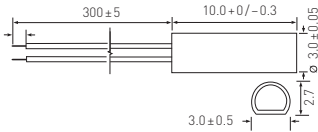

MS-210

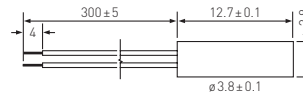

MS-211

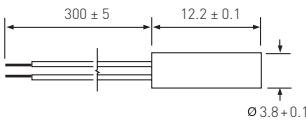

MS-213

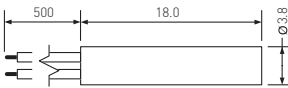

MS-214



MS-215

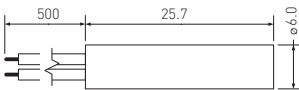

MS-216

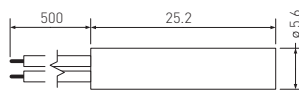

MS-217

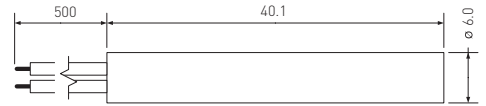

		MS-208	MS-209	MS-210	MS-211	MS-213	MS-214	MS-215-3	MS-215-4	MS-215-5	MS-217-6	MS-215-7	MS-216-7	MS-217-7
Contact Form		A	A	A	A	A	A	A	C	A	A	B		
Contact Rating (max.)	W/VA	5	10	10	10	10	10	10	5	10	50	5		
Switching Current (max.)	A	0.35	0.5	0.5	0.5	0.7	0.7	1	0.25	0.3	1.5	0.25		
Switching Voltage (max.)	VDC	175	150	150	150	180	180	200	175	200	200	175		
	VAC	140	120	120	120	130	130	140	120	260	250	120		
Pull in range available	AT	5-15	10-20	10-20	10-20	10-25	10-25	10-25	15-30	15-30	25-40	15-30		
Operating Temperature	°C	-20 to +85	-30 to +80	-30 to +80	-30 to +80	-20 to +85	-20 to +85	-20 to +85	-20 to +85	-20 to +85	-20 to +85	-20 to +85		
	UL/CSA/RoHS	--/--/•	--/--/•	--/--/•	--/--/•	•/--/•	•/--/•	•/•/•	•/•/•	•/•/•	•/•/•	•/•/•		
Housing Material		ABS												
Cable Type		AWG 30	AWG 30	AWG 26	AWG 26	AWG 26	AWG 26	AWG 24	AWG 24	AWG 24	AWG 24	AWG 24	AWG 24	AWG 24

AT ranges and characteristics stated for unmodified Reed Switches. Pls. refer page 52-54 for additional technical information. All dimensions in mm. Subject to change without prior notice.

# Tubular Threaded

## Features

- Adjustable switching point
- Replaces various competitors types
- Mains voltage variants available
- Various sensitivity ranges available
- Customized types available



MS-225

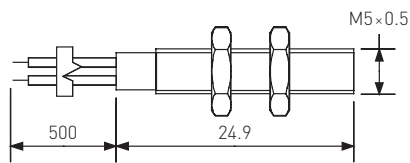

MS-228

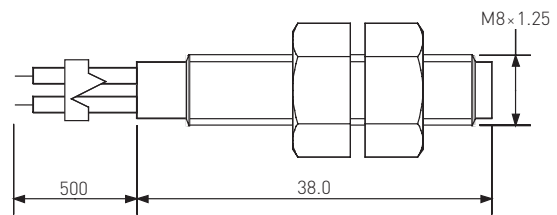

		MS-225	MS-228-3	MS-228-4	MS-228-5	MS-228-6	MS-228-7
Contact Form		A	A	C	A	A	B
Contact Rating (max.)	W/VA	10	10	5	10	50	5
Switching Current (max.)	A	1	1	0.25	0.3	1.5	0.25
Switching Voltage (max.)	VDC	180	200	175	200	200	175
	VAC	130	140	120	260	250	120
Pull in range available	AT	10-25	10-25	15-30	15-30	25-40	15-30
Operating Temperature	°C	-20 to +85	-20 to +85	-20 to +85	-20 to +85	-20 to +85	-20 to +85
UL/CSA/RoHS		•/-/•	•/•/•	•/•/•	•/•/•	•/•/•	•/•/•
Housing Material	Nickel plated brass	PA6-GF	PA6-GF	PA6-GF	PA6-GF	PA6-GF	PA6-GF
Cable Type	AWG 28	AWG 24	AWG 24	AWG 24	AWG 24	AWG 24	AWG 24

Matching actuators on page 38.

AT ranges and characteristics stated for unmodified Reed Switches. Pls. refer page 52-54 for additional technical information. All dimensions in mm. Subject to change without prior notice.

## Tubular Threaded

## Features

Adjustable switching point

Rugged design



MS-226M

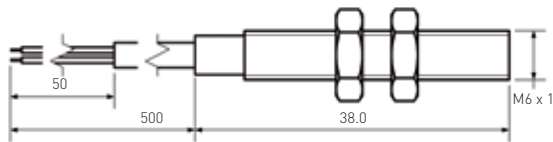

MS-228M

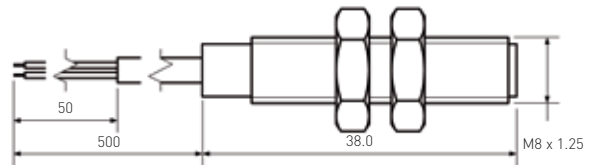

MS-2210M

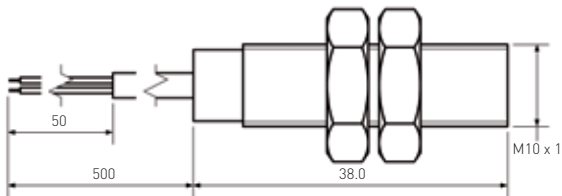

MS-2212M

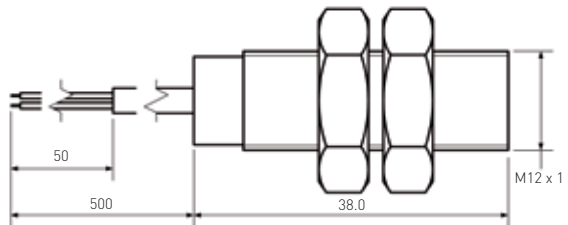

	Power Switch	Normally Closed
MS-226M-3 MS-228M-3 MS-2210M-3 MS-2212M-3	MS-228M-6 MS-2210M-6 MS-2212M-6	MS-2210-7

Contact Form		A	A	B
Contact Rating (max.)	W/VA	10	50	5
Switching Current (max.)	A	1	1.5	0.25
Switching Voltage (max.)	VDC	200	200	175
	VAC	140	250	120
Pull in range available	AT	10–25	25–40	15–30
Operating Temperature	°C	–20 to +85	–20 to +85	–20 to +85
UL/CSA/RoHS		--/--/•	--/--/•	--/--/•
Housing Material		Nickel plated brass	Nickel plated brass	Nickel plated brass
Cable Type		AWG 24 (MS-226M-3: AWG 28)	AWG 24	AWG 24

Matching actuators on page 38.

AT ranges and characteristics stated for unmodified Reed Switches. Pls. refer page 52–54 for additional technical information. All dimensions in mm. Subject to change without prior notice.



### Features

Easily mountable, no tools or screws required

Various sensitivity ranges available

Customized sizes and diameters available



MS-2431

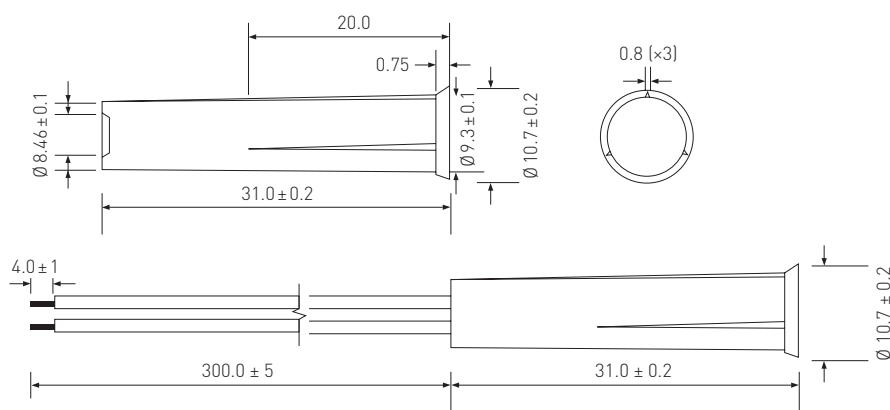

		MS-2431-3	MS-2431-4	MS-2431-7
Contact Form		A	C	B
Contact Rating (max.)	W/VA	10	3	3
Switching Current (max.)	A	1	0.2	0.2
Switching Voltage (max.)	VDC	200	30	30
	VAC	140	30	30
Pull in range available	AT	10-25	10-30	10-30
Operating Temperature	°C		-20 to +85	
UL/CSA/RoHS			--/--/•	
Housing Material			PA-GF	
Cable Type			AWG 24	

Matching actuators on page 38.

AT ranges and characteristics stated for unmodified Reed Switches. Pls. refer page 52-54 for additional technical information. All dimensions in mm. Subject to change without prior notice.

## Snap-fit

### Features

- /// Easily mountable and removable as no tools or screws required
- /// Small size
- /// Various sensitivity ranges available
- /// Customized types available



MS-320

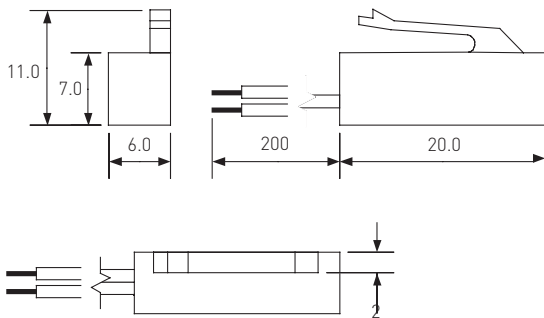

MS-390

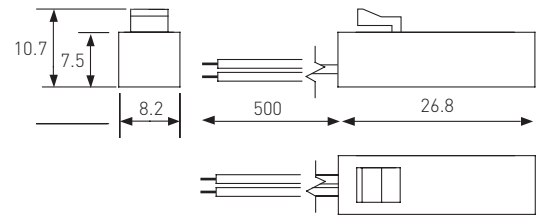

		MS-320	MS-390-3	MS-390-4	MS-390-5
Contact Form		A	A	C	A
Contact Rating (max.)	W/VA	10	10	5	10
Switching Current (max.)	A	0.7	1	0.25	0.3
Switching Voltage (max.)	VDC	180	200	175	200
	VAC	130	140	120	260
Pull in range available	AT	10–25	15–30	15–30	15–30
Operating Temperature	°C	–20 to +85			
UL/CSA/RoHS		•/•/•		--/--/•	
Housing Material		PA-GF		PC	
Cable Type		AWG 22	AWG 22	AWG 24	AWG 22

AT ranges and characteristics stated for unmodified Reed Switches. Pls. refer page 52–54 for additional technical information. All dimensions in mm. Subject to change without prior notice.

## Hall & TMR Sensors

*[Hall or TMR ICs used as Sensors with housings, cable and possible connector; allowing high switching frequencies and more switching cycles than Reed Switches, especially suitable for continuous counting applications.]*

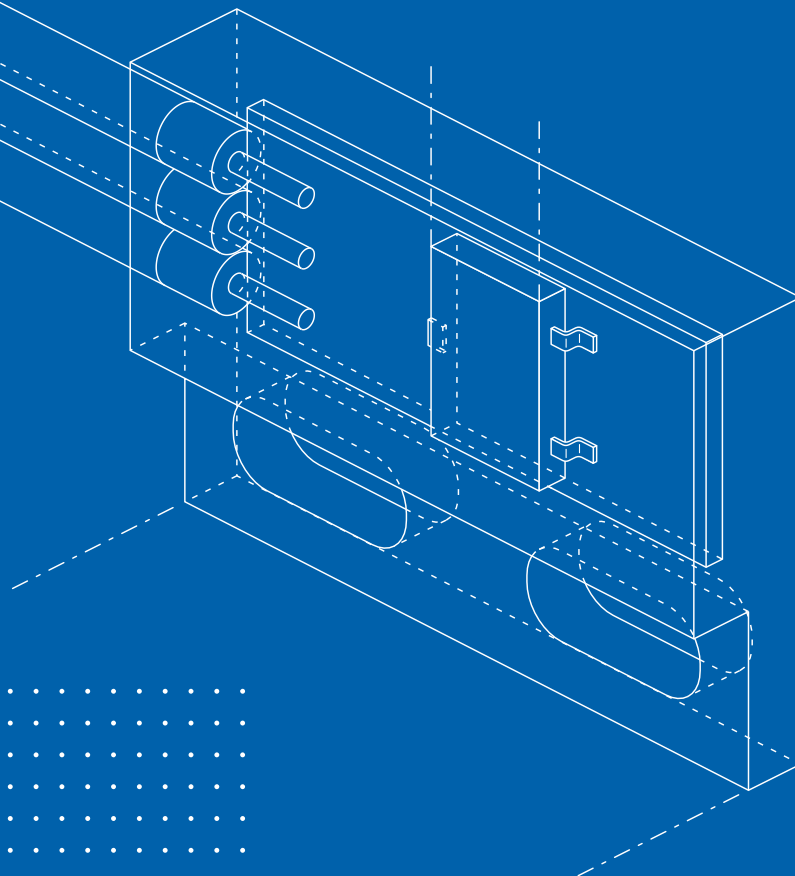
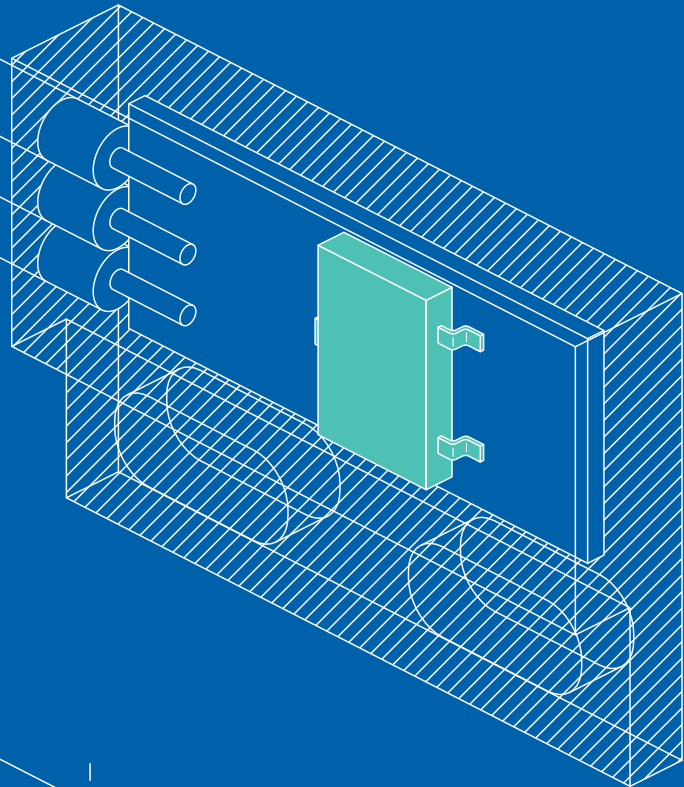

## How does a Hall & TMR Sensors work?

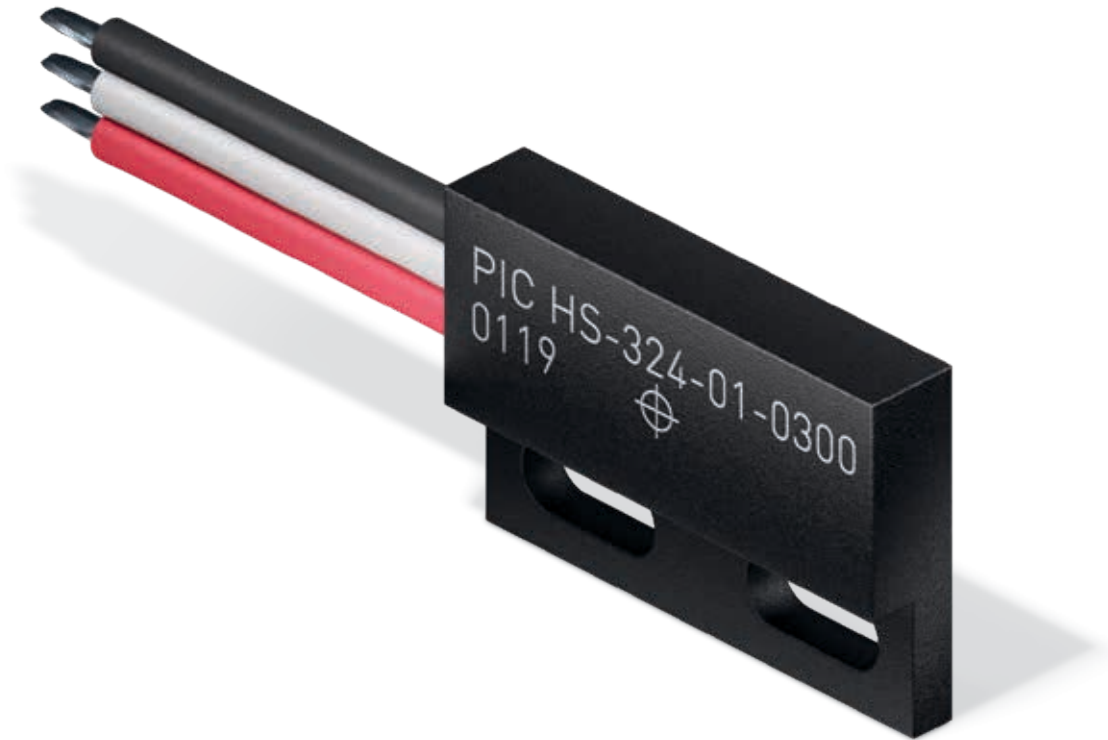

A Hall Sensor contains an IC which reacts to a magnetic field by changing its output status. This change can be interpreted as ON/OFF signal by a logic.

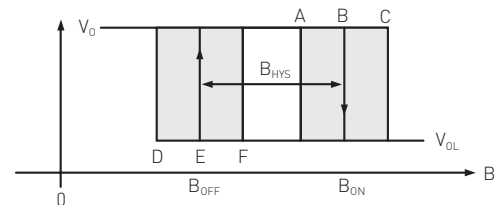
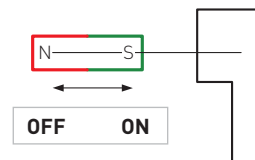

A TMR Sensor contains an IC which reacts to a magnetic field by changing its resistance. This change can be interpreted as ON/OFF signal by a logic.

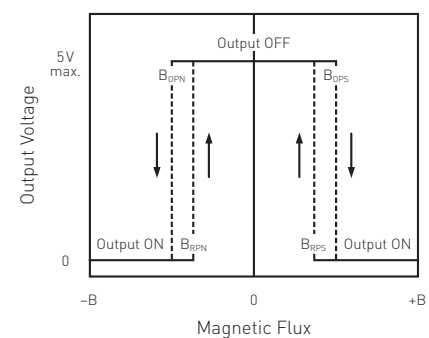
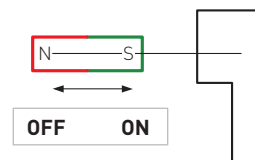

### Benefits

- ▣ No mechanical movement, basically no wear
- ▣ Higher "switching frequency" compared to Reed Sensors
- ▣ Mechanically protected
- ▣ Easy assembly

## Features

- Compact housing
- Ideal sensing point marked
- Various chip positions inside the housing possible



### HS-324

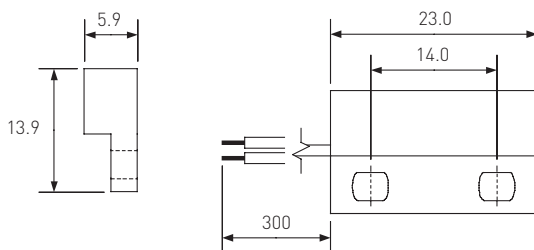

### HS-324R

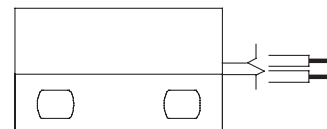



		HS-324-01 HS-324R-01	HS-324-02 HS-324R-02	HS-324-03 HS-324R-03	HS-324-04 HS-324R-04	HS-324-05 HS-324R-05
Type		Bipolar	Latching	Unipolar	Latching	Unipolar
Wires		3 wire	3 wire	3 wire	2 wire	2 wire
B <sub>ON</sub> /B <sub>OFF</sub>	mT	0.5/-0.5	2.5/-2.5	5.5/3.5	12.0/-12.0	6.0/4.0
Supply Current I <sub>s</sub> (max.)	mA	2.4	2.4	2.4	5	2
Supply Voltage (min.)	V	2.7	2.7	2.7	3.0	3.0
Operating Temperature	°C	-20 to +85				
Housing Material		ABS				
Cable Type		AWG 24				

All dimensions in mm. Subject to change without prior notice.

## Tubular Threaded

## Features

 Adjustable switching point

 Rugged design

 Ideal sensing point on front side

HS-2210M

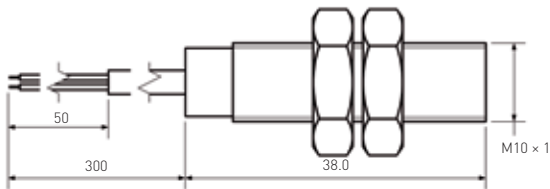

HS-2212M

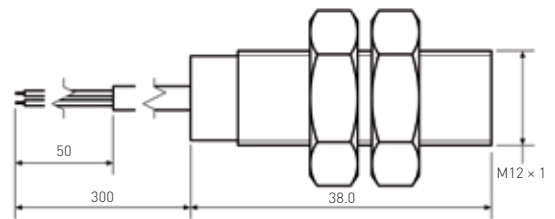

		HS-2210M-01 HS-2212M-01	HS-2210M-02 HS-2212M-02	HS-2210M-03 HS-2212M-03	HS-2210M-04 HS-2212M-04	HS-2210M-05 HS-2212M-05
Type		Bipolar	Latching	Unipolar	Latching	Unipolar
Wires		3 wire	3 wire	3 wire	2 wire	2 wire
B <sub>ON</sub> /B <sub>OFF</sub>	mT	0.5/-0.5	2.5/-2.5	5.5/3.5	12.0/-12.0	6.0/4.0
Supply Current I <sub>S</sub> (max.)	mA	2.4	2.4	2.4	5	2
Supply Voltage (min.)	V	2.7	2.7	2.7	3.0	3.0
Operating Temperature	°C	-20 to +85				
Housing Material		Nickel plated brass				
Cable Type		AWG 24				

All dimensions in mm. Subject to change without prior notice.

## Features

Ultra compact housing

Various sensitivities

Customized types available



**HS-3511**  
3 wire

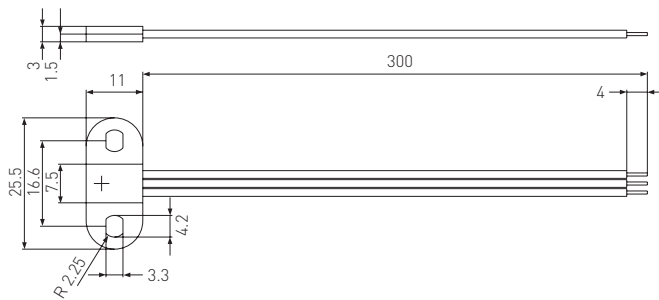

**HS-3511**  
2 wire

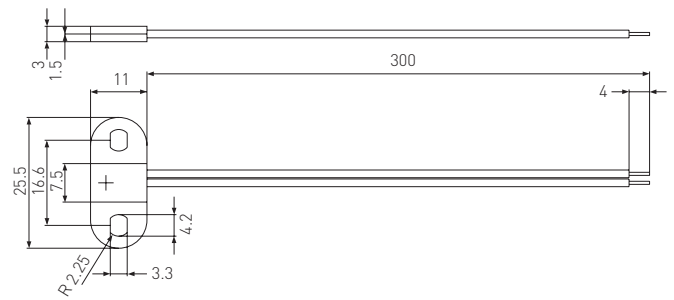





		HS-3511-01	HS-3511-02	HS-3511-03	HS-3511-04	HS-3511-05
Type		Bipolar	Latching	Unipolar	Latching	Unipolar
Wires		3 wire	3 wire	3 wire	2 wire	2 wire
$B_{ON}/B_{OFF}$	mT	0.5/-0.5	2.5/-2.5	5.5/3.5	12.0/-12.0	6.0/4.0
Supply Current $I_S$ (max.)	mA	2.4	2.4	2.4	5	2
Supply Voltage (min.)	V	2.7	2.7	2.7	3.0	3.0
Operating Temperature	°C	-20 to +85				
Housing Material		PA6				
Cable Type		AWG 24				

All dimensions in mm. Subject to change without prior notice.

# Flatpack

## Features

-  Compact size
-  CMOS push-pull output
-  Ultra-Low power consumption
-  Excellent thermal stability



TS-324

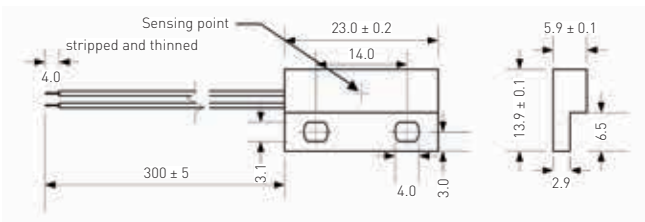

TS-324R

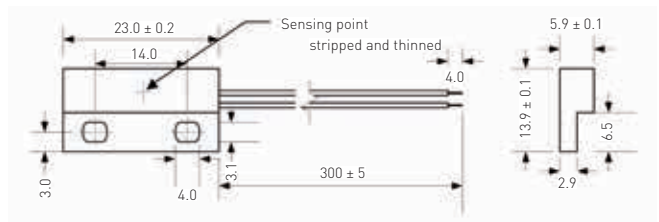

		TS-324-01 TS-324R-01	TS-324-02 TS-324R-02	TS-324-03 TS-324R-03	TS-324-04 TS-324R-04	TS-324-05 TS-324R-05
Type		Bipolar	Bipolar	Omnipolar	Omnipolar	Omnipolar
Wires		3 wire	3 wire	3 wire	3 wire	3 wire
B <sub>ON</sub> /B <sub>OFF</sub>	mT	1.7/-1.7	0.5/-0.5	±3.5/ ±2.2	±1.7/ ±1.0	±0.5/ ±0.4
Supply Current I <sub>s</sub> (max.)	mA	1.5	1.5	1.5	1.5	1.5
Supply Voltage (min.)	V	1.8	1.8	1.8	1.8	1.8
Operating Temperature	°C	-20 to +85	-20 to +85	-20 to +85	-20 to +85	-20 to +85
Housing Material		ABS	ABS	ABS	ABS	ABS
Cable Type		AWG 24	AWG 24	AWG 24	AWG 24	AWG 24

All dimensions in mm. Subject to change without prior notice.



# Tubular Threaded

## Features

Compact size

CMOS push-pull output

Ultra-Low power consumption

Excellent thermal stability

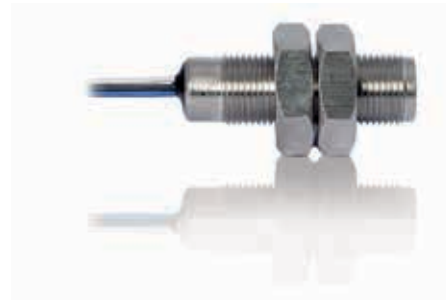

TS-2210M

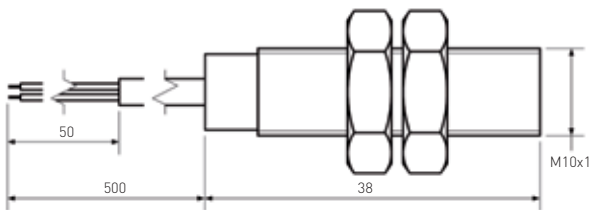

TS-2212M

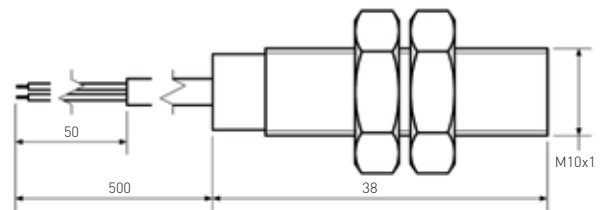

		TS-2210M-01 TS-2212M-01	TS-2210M-02 TS-2212M-02	TS-2210M-03 TS-2212M-03	TS-2210M-04 TS-2212M-04	TS-2210M-05 TS-2212M-05
Type		Bipolar	Bipolar	Omnipolar	Omnipolar	Omnipolar
Wires		3 wire	3 wire	3 wire	3 wire	3 wire
$B_{ON}/B_{OFF}$	mT	1.7/-1.7	0.5/-0.5	$\pm 3.5/\pm 2.2$	$\pm 1.7/\pm 1.0$	$\pm 0.5/\pm 0.4$
Supply Current $I_s$ (max.)	mA	1.5	1.5	1.5	1.5	1.5
Supply Voltage (min.)	V	1.8	1.8	1.8	1.8	1.8
Operating Temperature	°C	-20 to +85	-20 to +85	-20 to +85	-20 to +85	-20 to +85
Housing Material		Nickel plated brass	Nickel plated brass	Nickel plated brass	Nickel plated brass	Nickel plated brass
Cable Type		AWG 24	AWG 24	AWG 24	AWG 24	AWG 24

All dimensions in mm. Subject to change without prior notice.

## Flange Mount

### Features

Compact size

CMOS push-pull output

Ultra-Low power consumption

Excellent thermal stability



TS-3511

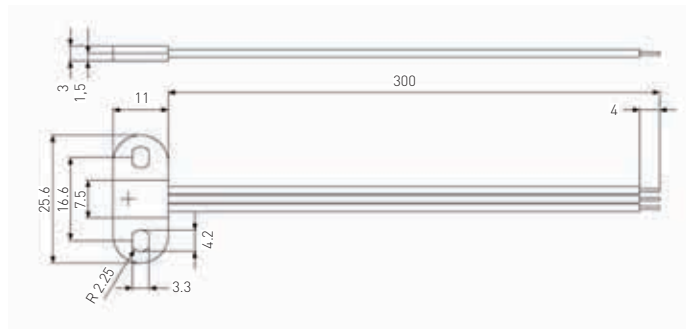

		TS-3511-01	TS-3511-02	TS-3511-03	TS-3511-04	TS-3511-05
Type		Bipolar	Bipolar	Omnipolar	Omnipolar	Omnipolar
Wires		3 wire	3 wire	3 wire	3 wire	3 wire
$B_{ON}/B_{OFF}$	mT	1.7/-1.7	0.5/-0.5	$\pm 3.5/\pm 2.2$	$\pm 1.7/\pm 1.0$	$\pm 0.5/\pm 0.4$
Supply Current $I_S$ (max.)	mA	1.5	1.5	1.5	1.5	1.5
Supply Voltage (min.)	V	1.8	1.8	1.8	1.8	1.8
Operating Temperature	°C	-20 to +85	-20 to +85	-20 to +85	-20 to +85	-20 to +85
Housing Material		PA6	PA6	PA6	PA6	PA6
Cable Type		AWG 24	AWG 24	AWG 24	AWG 24	AWG 24

All dimensions in mm. Subject to change without prior notice.

## Magnets

*[Material with magnetic properties; used for Reed Switch and Hall-Sensor actuation; magnetic material is matched to specific usage scenarios; can also be provided in housings.]*

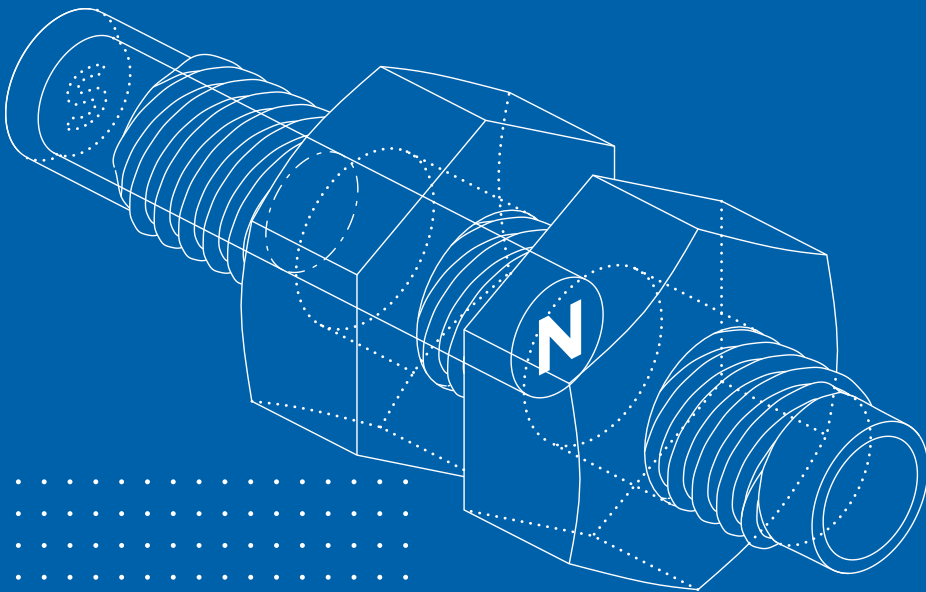
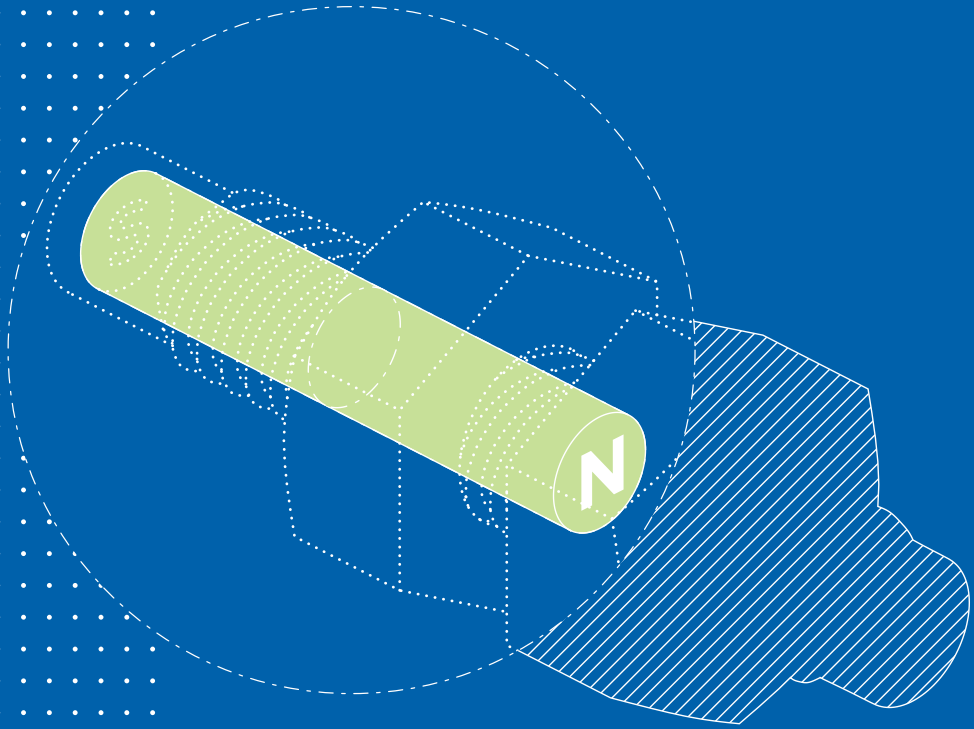

## How does a Magnet work?



A Magnet creates a magnetic field that attracts other magnetic materials like iron. After their magnetization permanent magnets keep their magnetic characteristics for a very long time.

Most Reed Sensor applications are operated by permanent magnets. The most common materials used in these applications are Ferrite, NdFeB (Neodymium-Iron-Boron), SmCo (Samarium-Cobalt) and AlNiCo (Aluminium-Nickel-Cobalt). We will specify the matching material, strength and form, according to the operating environment.

### Benefits

- Matching magnet for your application
- Magnets with or without housing available
- Switching component and complementary Magnet
- Simple procurement, Plug&Play sensor solutions

Check table below for most suitable magnet material.

Selection Guide

LOW  HIGH

Costs	Ferrite	AlNiCo	NdFeB	SmCo
Energy Product	Ferrite	AlNiCo	SmCo	NdFeB
Operating Temperature	NdFeB	Ferrite	SmCo	AlNiCo
Corrosion Resistance	NdFeB	SmCo	AlNiCo	Ferrite
Resistance to Demagnetization	AlNiCo	Ferrite	NdFeB	SmCo
Mechanical Strength	Ferrite	SmCo	NdFeB	AlNiCo
Temperature Coefficient	AlNiCo	SmCo	NdFeB	Ferrite

### Maximum power, minimum space

In recent years, Neodymium-Iron-Boron magnets (NdFeB) have advanced from being exotic luxury items to affordable power magnets.



## The benefits in sensor applications

Increased switching distance

Miniature design possible

Resistance to demagnetization

Greater product design flexibility

Material Grades	Remanence Br	Coercivity		Energy Product (BH) max.	Operating Temperature max.	
		HcB	HcJ			
	mT	kA/m	kA/m	kJ/m <sup>3</sup>	°C	
NdFeB	N30	1105	836	955	235	80
	N30H	1105	836	1274	235	120
	N30SH	1100	836	1512	239	150
	N33EH	1185	828	955	275	180
	N35	1185	828	955	275	80
	N35H	1190	828	1274	275	120
	N35SH	1190	828	1512	275	150
	N40SH	1260	844	1512	314	150
	N45	1350	840	955	354	80
N48H	1395	955	1353	378	120	
SmCo5	S20	875	617	1194	159	250
Sm2Co17	S24H	975	724	1433	183	300
	S28H	1065	724	1433	215	300
AlNiCo	A500	1281	50	52	40	500
Ferrite	Y10	215	143	203	8	250
	Y30BH	390	229	231	29	300
	Y35	410	183	167	31	300
Bonded Ferrite	FB1	240	171	225	11	80
Bonded NdFeB	BN8	575	378	1035	64	150

Typical values, may vary!

## Features

- Easily mountable
- Matches chosen Sensor
- Mechanically protected
- Customized types available



MSM-2431

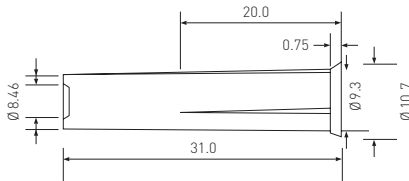

MSM-313

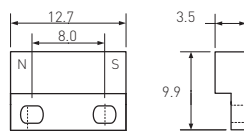

MSM-320

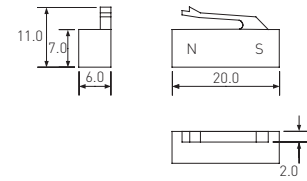

MSM-324

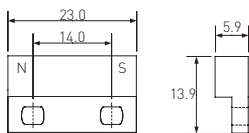

MSM-328

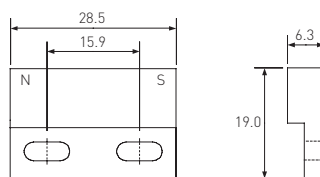

MSM-332

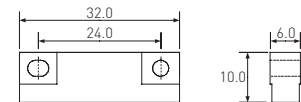

		MSM-2431	MSM-313	MSM-320	MSM-324	MSM-328	MSM-332
Remanence Br	mT	1190	1395	1190	1105	1105	1105
Coercivity HcB	kA/m	870	955	-	836	836	836
Coercivity HcJ	kA/m	1350	1353	1512	1274	1274	1274
Energy Product (BH) (max.)	kJ/m <sup>3</sup>	275	378	275	235	235	235
Magnetic Moment M	x 10 <sup>-5</sup> Vs cm	10.0	0.3	2.4	3.42	3.42	4.1
Operating Temperature	°C	-20 to +85	-20 to +85	-20 to +85	-20 to +85	-20 to +85	-20 to +85
UL/CSA/RoHS		--/--/•	--/--/•	--/--/•	--/--/•	--/--/•	--/--/•
Housing Material		PA-GF	ABS	PA-GF	ABS	PA-GF	ABS

All dimensions in mm. Subject to change without prior notice.



MSM-225

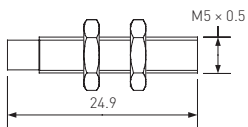

MSM-226M

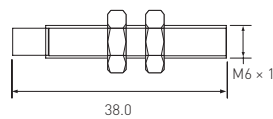

MSM-228

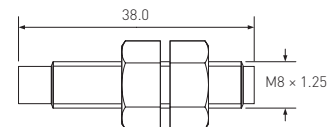

MSM-228M

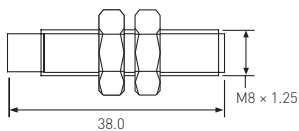

MSM-2210M

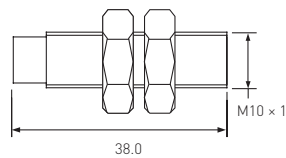

MSM-2212M

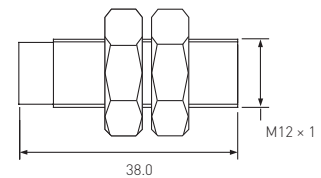

		MSM-225	MSM-226M	MSM-228	MSM-228M	MSM-2210M	MSM-2212M
Remanence Br	mT	1105	1105	1190	1190	1105	1105
Coercivity HcB	kA/m	836	836	828	828	836	836
Coercivity HcJ	kA/m	1274	1274	1274	1274	1274	1274
Energy Product (BH) (max.)	kJ/m <sup>3</sup>	235	235	275	235	235	235
Magnetic Moment M	x10 <sup>-5</sup> Vs cm	1.21	14.6	1.5	25.5	43.6	43.6
Operating Temperature	°C	-20 to +85	-20 to +85	-20 to +85	-20 to +85	-20 to +85	-20 to +85
UL/CSA/RoHS		--/--/•	--/--/•	--/--/•	--/--/•	--/--/•	--/--/•
Housing Material		Nickel plated brass	Nickel plated brass	PA-GF	Nickel plated brass	Nickel plated brass	Nickel plated brass

All dimensions in mm. Subject to change without prior notice.

## Level Sensors

*[Combining a Reed Switch and a Floating Magnet into one unit for detecting liquid levels; one or more switching points possible.]*

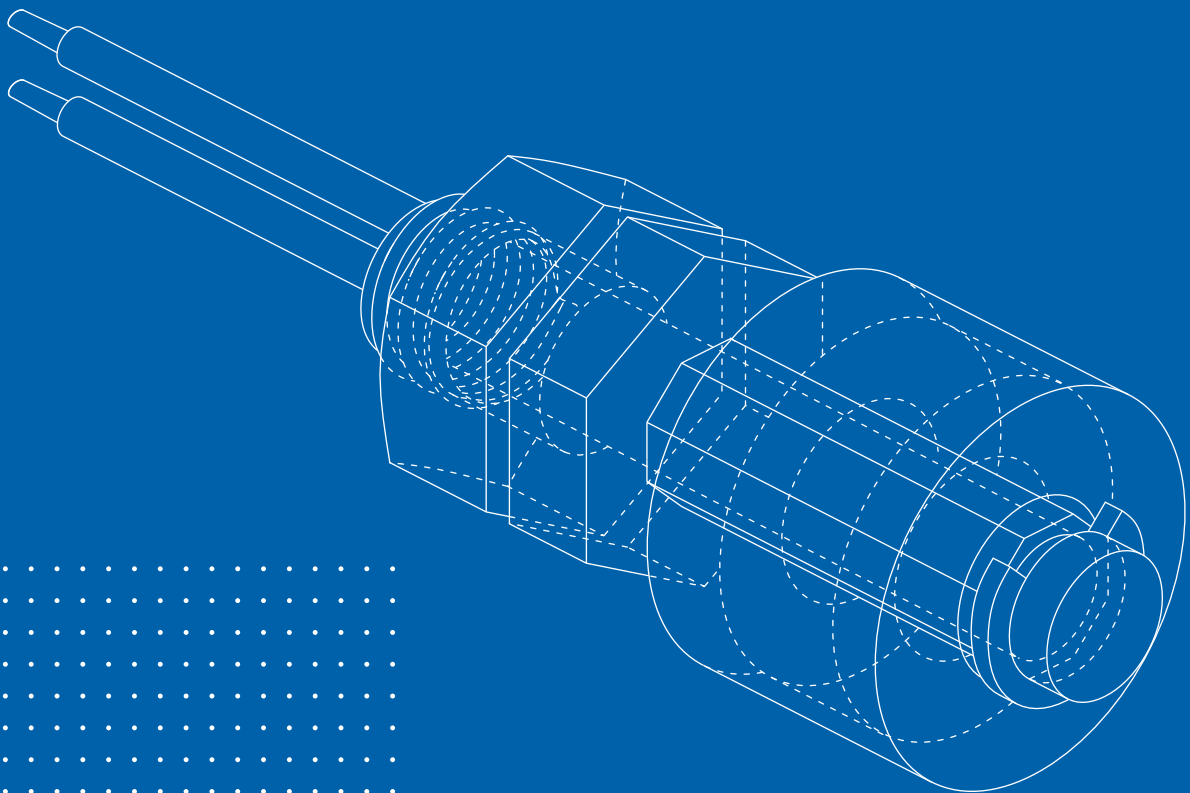
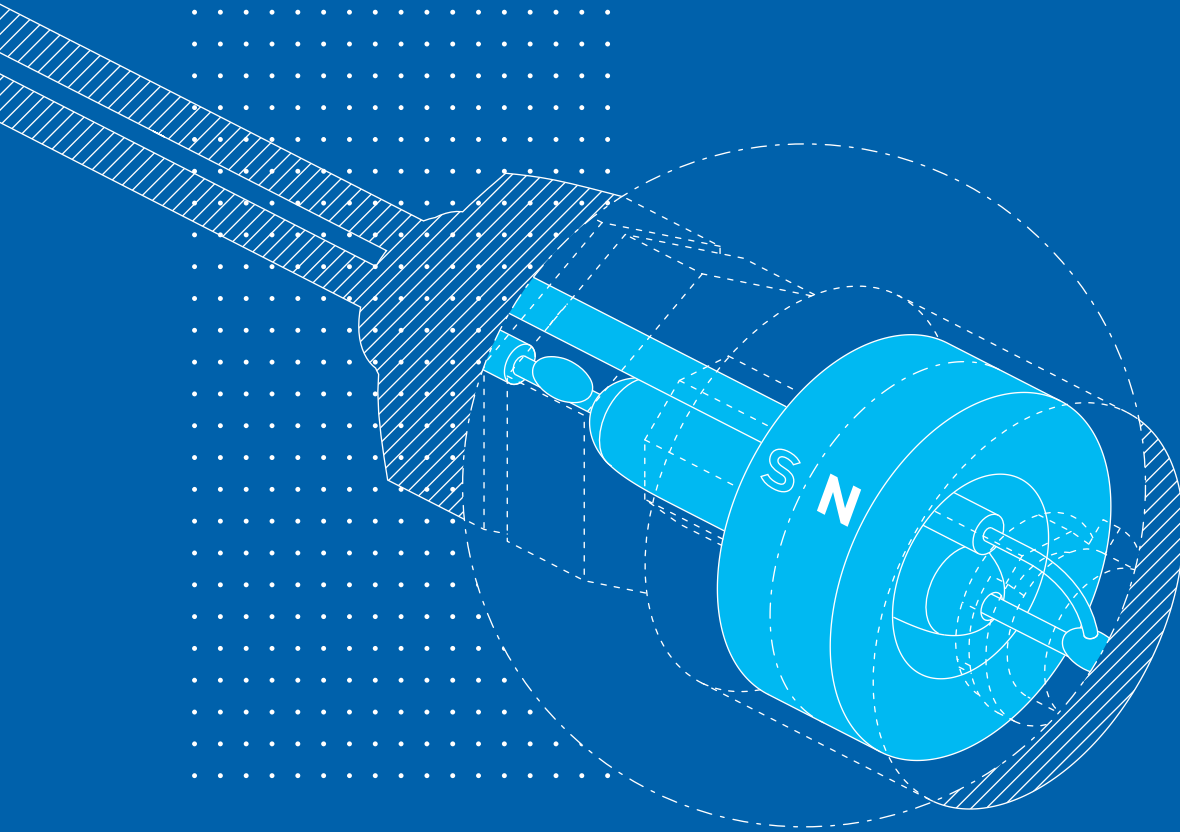



**How does a Level Sensor work?**

A Level Sensor incorporates a Reed Switch in a stem. An external float, with a magnet inside, passes and actuates the Reed Switch, depending on liquid level. Actuation principles for Reed Switches also apply to Level Sensors.

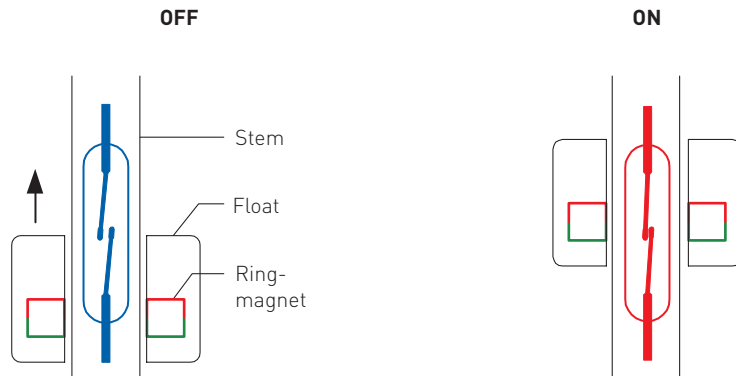

**Benefits**

- /// No power supply required
- /// Various housing materials available
- /// Form A and Form B
- /// Suitable for food contact
- /// Customized types available

**FORM A (Normally Open)**

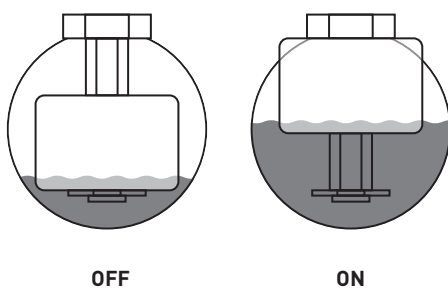

**FORM B (Normally Closed)**

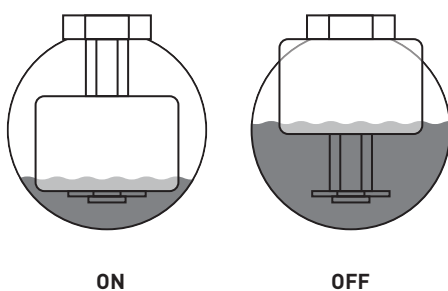

When mounted "stem up", operating functions are reversed.

**Top Mounting**

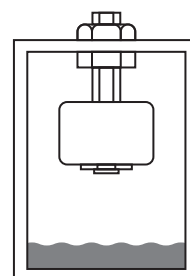



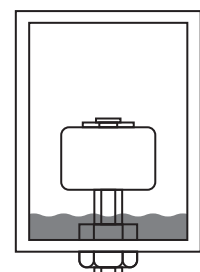

**Bottom Mounting**



## PLS-PP-Series

### Features

-  Polypropylene housing
-  Form A and Form B
-  Suitable for food contact
-  Covers a wide range of applications
-  Customized types available



PLS-020 – World's smallest!

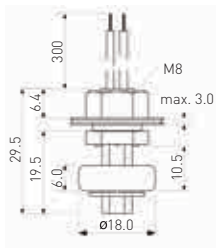

PLS-031 – Miniature

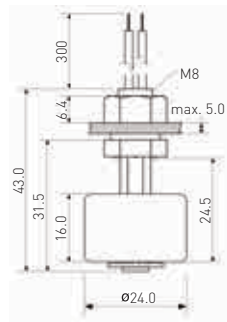

PLS-041 – Standard

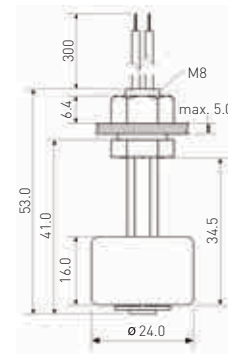

		Power Switch					
		PLS-020A-3PPI	PLS-020B-3PPI	PLS-031A-3PPI	PLS-031B-3PPI	PLS-041A-6PPI	PLS-041B-6PPI
Contact Form		A	B	A	B	A	B
Contact Rating (max.)	W/VA	10		10		50	
Switching Current (max.)	A	0.7		1		1.5	
Carry Current (max.)	A	1		1.2		2	
Switching Voltage (max.)	VDC	180		200		200	
	VAC	130		140		250	
Breakdown Voltage (min.)	VDC	200		240		400	
Operating Temperature	°C	-20 to +80		-20 to +80		-20 to +80	
UL/CSA/RoHS		●/●/●		●/●/●		●/●/●	
Housing Material		PP		PP		PP	
Cable Type		AWG 24		AWG 24		AWG 22	

## Features

Customized types available

FDA tested

Polypropylene housing

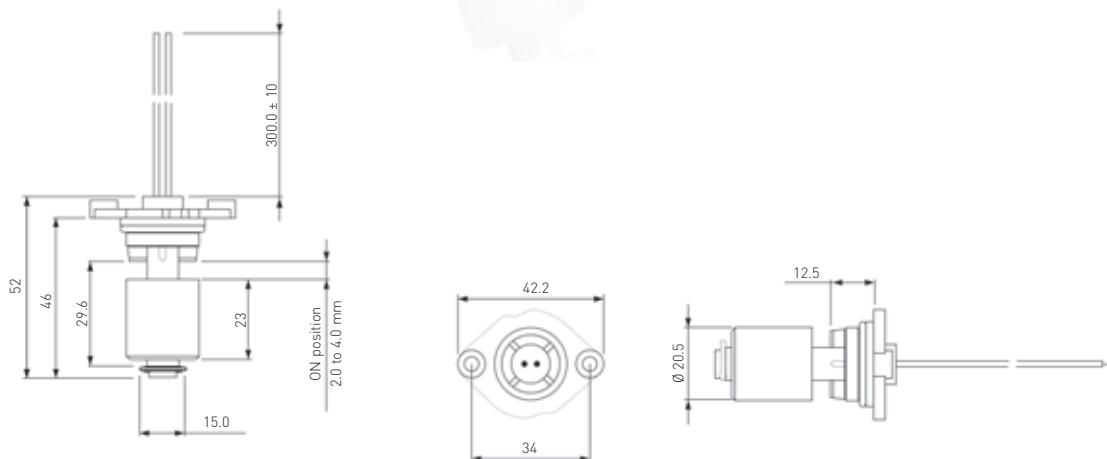





		Power Switch			
		PLS-051A-3PPI	PLS-051B-3PPI	PLS-051A-6PPI	PLS-051B-6PPI
Contact Form		A	B	A	B
Contact Rating (max.)	W/VA	10		50	
Switching Current (max.)	A	0.5		1.5	
Carry Current (max.)	A	1		2	
Switching Voltage (max.)	VDC	200		200	
	VAC	140		250	
Breakdown Voltage (min.)	VDC	250		400	
Operating Temperature	°C	-20 to +80		-20 to +80	
UL/CSA/RoHS		--/--/•		--/--/•	
Housing Material		PP			
Cable Type		AWG 24		AWG 22	

Pls. refer page 54 for additional information on housing material and media. All dimensions in mm. Subject to change without prior notice. The density of the applicable medium has to be 20% above the density of the used float material to ensure proper and secure function.

## PLS-PA-Series

### Features

-  Polyamide housing
-  Form A and Form B
-  Suitable for food contact
-  Covers a wide range of applications
-  Customized types available



PLS-031 – Miniature

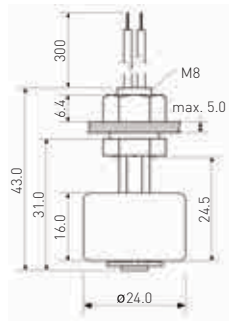

PLS-041 – Standard

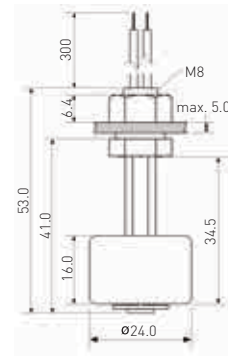

		Power Switch							
		PLS-031A-3PAI PLS-041A-3PAI		PLS-031B-3PAI PLS-041B-3PAI		PLS-031A-6PAI PLS-041A-6PAI		PLS-031B-6PAI PLS-041B-6PAI	
Contact Form		A		B		A		B	
Contact Rating (max.)	W/VA	10		10		50		50	
Switching Current (max.)	A	1		1		1.5		1.5	
Carry Current (max.)	A	1.2		1.2		2		2	
Switching Voltage (max.)	VDC	200		200		200		200	
	VAC	140		140		250		250	
Breakdown Voltage (min.)	VDC	240		240		400		400	
Operating Temperature	°C	-20 to +80		-20 to +80		-20 to +80		-20 to +80	
UL/CSA/RoHS		•/•/•		•/•/•		•/•/•		•/•/•	
Housing Material		PA - GF		PA - GF		PA - GF		PA - GF	
Cable Type		AWG 24		AWG 24		AWG 22		AWG 22	

Pls. refer page 54 for additional information on housing material and media. All dimensions in mm. Subject to change without prior notice.  
The density of the applicable medium has to be 20% above the density of the used float material to ensure proper and secure function.

### Features

-  Stainless Steel housing
-  Rugged & durable
-  Form A and Form B
-  Suitable for food contact
-  Extended temperature range
-  Customized types available



**PLS-045**

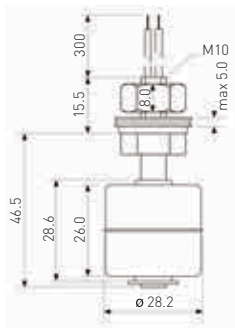

**PLS-080**

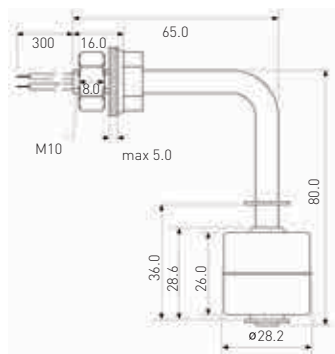

**PLS-081**

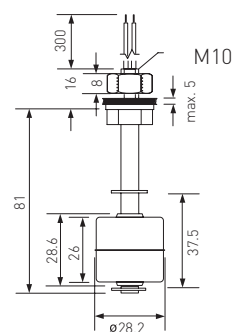

	Power Switch			
PLS-045A-3VAI	PLS-045B-3VAI	PLS-045A-6VAI	PLS-045B-6VAI	
PLS-080A-3VAL	PLS-080B-3VAL	PLS-080A-6VAL	PLS-080B-6VAL	
PLS-081A-3VAI	PLS-081B-3VAI	PLS-081A-6VAI	PLS-081B-6VAI	

		A		B		A		B	
Contact Form		A		B		A		B	
Contact Rating (max.)	W/VA	10		50					
Switching Current (max.)	A	1		1.5					
Carry Current (max.)	A	1.2		2					
Switching Voltage (max.)	VDC	200		200					
	VAC	140		250					
Breakdown Voltage (min.)	VDC	240		400					
Operating Temperature	°C	-40 to +125		-40 to +125					
UL/CSA/RoHS*		●/●/●		●/●/●					
Housing Material		Stainless Steel		Stainless Steel					
Cable Type		AWG 24		AWG 22					

Pls. refer page 54 for additional information on housing material and media. All dimensions in mm. Subject to change without prior notice.  
 The density of the applicable medium has to be 20% above the density of the used float material to ensure proper and secure function.

\*PLS-081 Series only RoHS

## PLS-PPH

## Features

-  Assembly from outside
-  Level Sensors for horizontal mounting
-  Polypropylene housing
-  Covers a wide range of applications

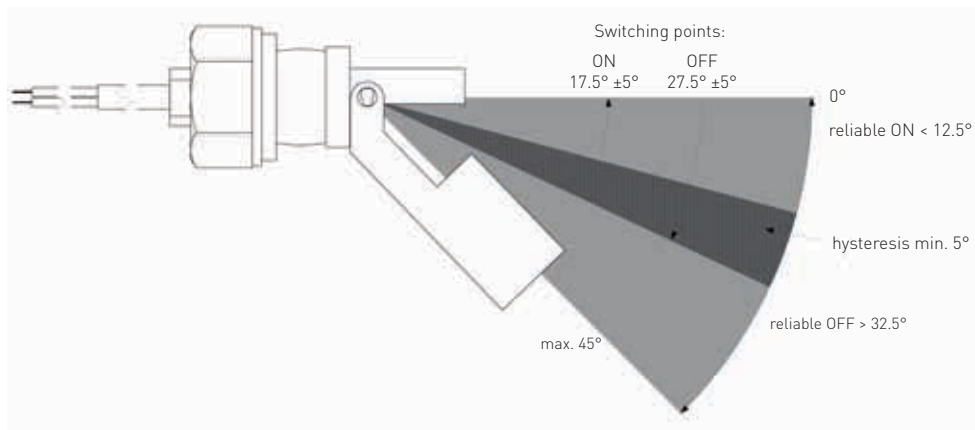
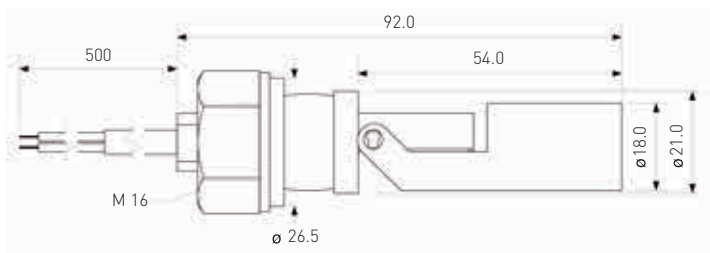

		PLS-092A-3PPH	PLS-092A-6PPH
Contact Form		A	A
Contact Rating (max.)	W/VA	10	50
Switching Current (max.)	A	1	1.5
Carry Current (max.)	A	1.2	2
Switching Voltage (max.)	VDC	200	200
	VAC	140	250
Breakdown Voltage (min.)	VDC	240	400
Operating Temperature	°C	-20 to +65	-20 to +65
UL/CSA/RoHS		--/--/•	--/--/•
Housing Material		PP	PP
Cable Type		AWG 22	AWG 22

Pls. refer page 54 for additional information on housing material and media. All dimensions in mm. Subject to change without prior notice.  
 The density of the applicable medium has to be 20% above the density of the used float material to ensure proper and secure function.

**Features**

PA, PP and VA for different liquids

Actuator for individual Level Sensors

Various shapes and materials available



**PFM-PP-Q001**



**PFC-2416-3  
PFC-2416-4**



**PFC-2828-2**

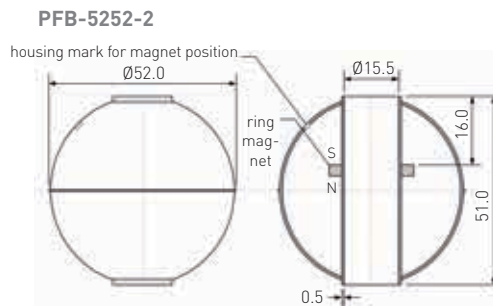
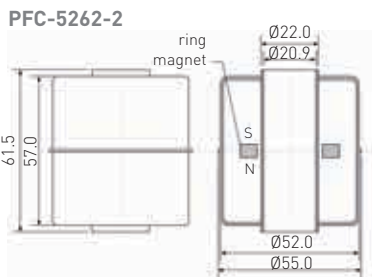
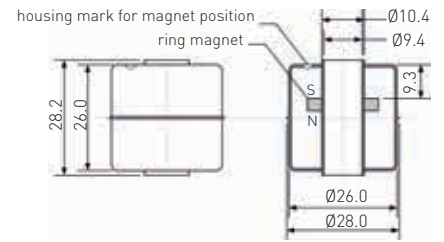
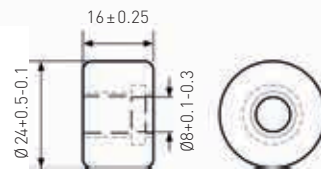
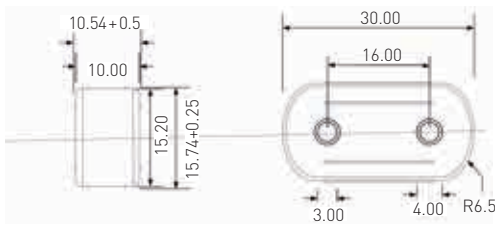

		PFM-PP-Q001	PFC-2416-3	PFC-2416-4	PFC-2828-2	PFC-5562-2	PFB-5252-2
Remanence Br	mT	1185	215	215	225	225	225
Coercivity HcB	kA/m	828	143	143	151	151	151
Coercivity HcJ	kA/m	955	203	203	271	271	271
Energy Product BH (max.)	kJ/m <sup>3</sup>	275	8	8	0.105	0.105	0.105
Magnetic Moment M	x10 <sup>-5</sup> VAC	1.6	4.1	4.1	-	-	-
Operating Temperature (max.)	°C	80	80	80	-40 to +150	-10 to +150	-10 to +180
UL/CSA/RoHS		--/--/•	--/--/•	--/--/•	--/--/•	--/--/•	--/--/•
Density of float typ.	g/cm <sup>3</sup>	0.88	0.7	0.76	0.7	0.73	0.6
Float Material		PP	PP	PA	Stainless Steel	Stainless Steel	Stainless Steel

All dimensions in mm. Subject to change without prior notice.

The density of the applicable medium has to be 20% above the density of the used float material to ensure proper and secure function.

## Customized Products

*[Customer specific, tailor made Sensing Solutions; fully adjusted to their targeted application; taking assembly situation, electrical parameters and design needs into consideration.]*

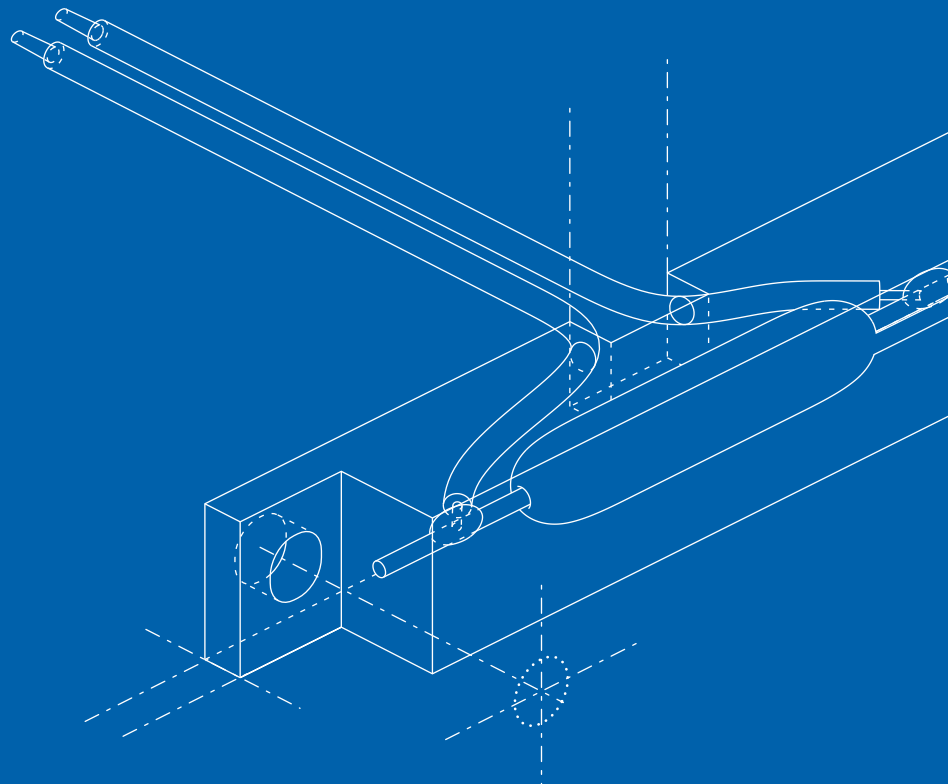
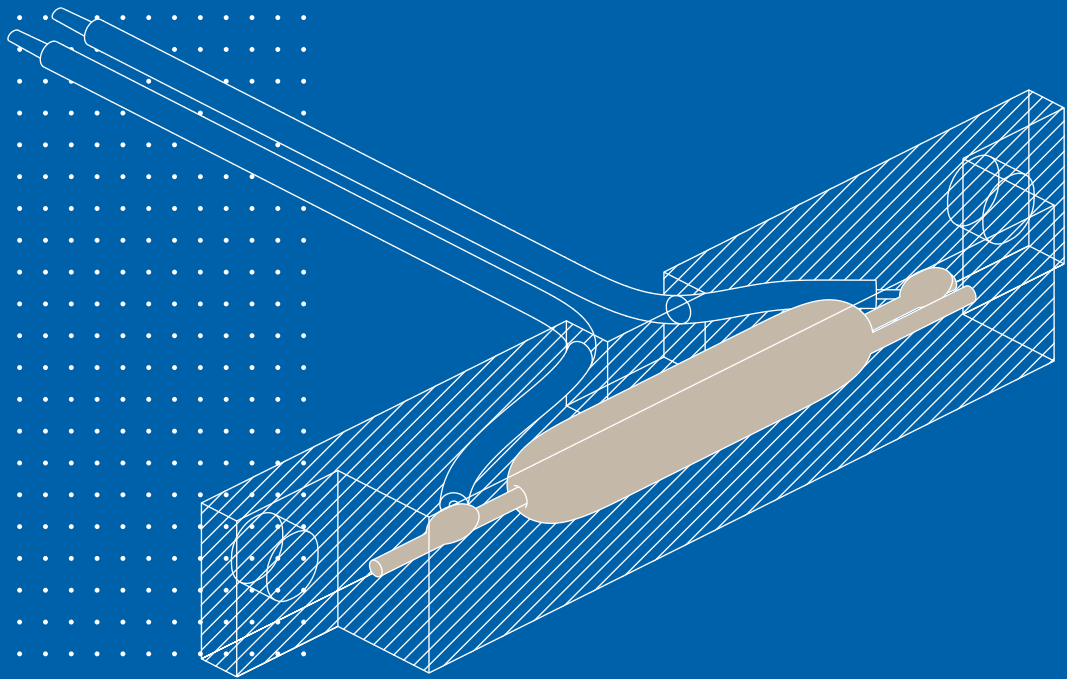



## How do Customized Products work?

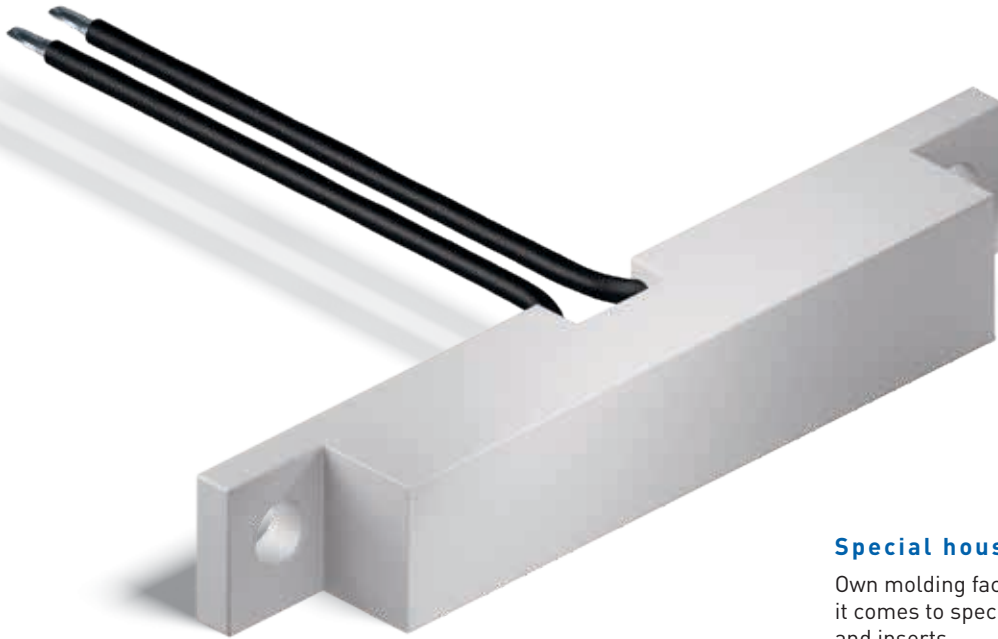

### Special housings

Own molding facilities spell flexibility when it comes to special housings, snap-fit solutions and inserts.

Depending on your application and the depth of needed specialization we consider a customized product to be a standard product with a reasonable grade of customization to create a cost efficient and safe to assemble sensor product.

Customer specific changes to our standard products could be the change of cable length and color, the attachment of terminals

or connectors, the usage of specific material (e.g. high temperature suitable) or the complete design and manufacturing of individual sensor housings.

Also Reed Switches can be customized to your needs by cutting and/or bending them at PIC – the simple and safe way to get a reliable switching element!

### Benefits

- Simple and safe assembly processes
- No need to send Sensors and Switches to third party suppliers
- Quality check and outgoing inspection through PIC, saves costs and minimizes scrap rates

## Examples

**Over 80% of our products are special custom designs.**



### Connectors and cable assemblies

Sensor solutions + wire harnesses:  
Taylor made to your requirements including RAST-Assembly

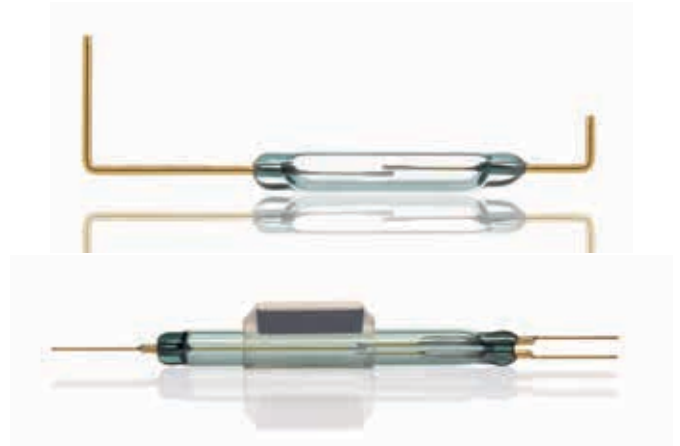

### Modified Reed Switches

We modify Reed Switches to your specific needs: Cutting, bending and even making them bistable – all done by experts in our own factories!



### Customized Level Sensors

We can do much more than what you see in this catalogue.

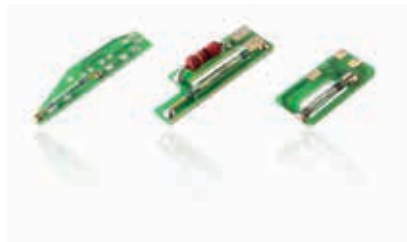

### PCB Assemblies

Where large quantities in particular are concerned, assembly costs can make or break a product. We will be happy to supply Reed Switches and other components as fully assembled PCBs including cable and connector at highly competitive prices.



### Flow Detection

Individual solutions for flow detection or even flow measuring, tailor made for your application.

## Technology

*[Property and behavior of Reed Switches and Reed Sensors; divisible into electrical and mechanical properties.]*

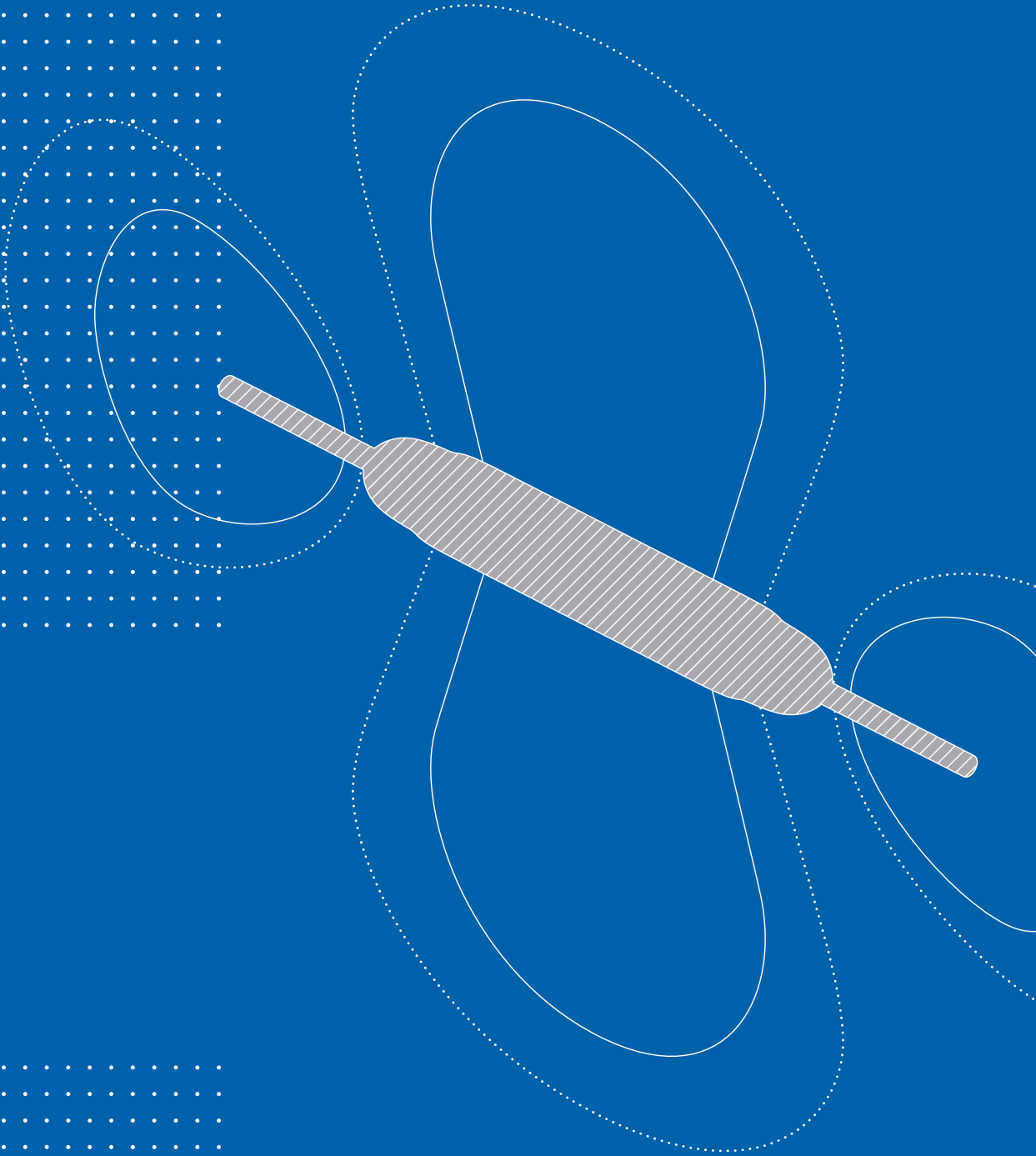
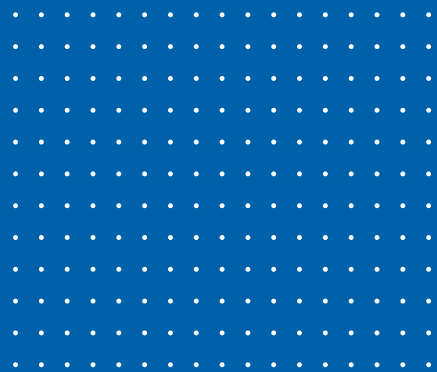
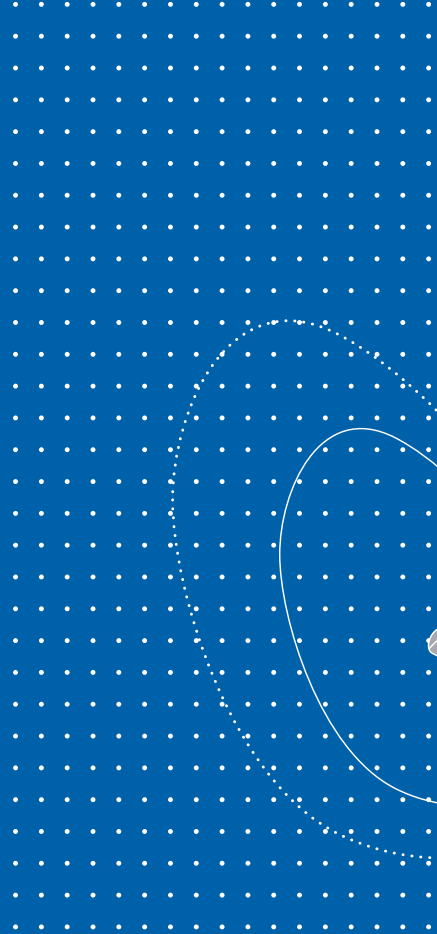

## Reed Switches: How to operate

### In general four different magnet approaches are known when using permanent magnets

- 1 **One magnet pole** faces Reed Switch providing **two** operations max. when moving on X-axis. Minimum movement of magnet over switch center provides smallest possible switching differential.

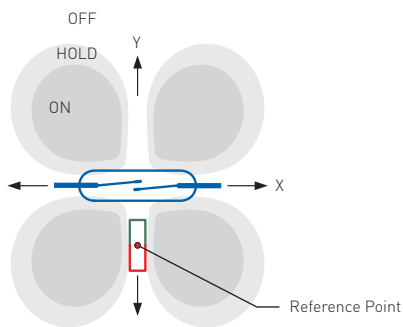

- 2 **Magnet parallel to longitudinal axis of switch:** Approaching magnet vertically to switch on Y-axis provides one operation only. Driving magnet over full length of switch (X-axis) may result in up to three operations. Minimum movement of magnet over switch center provides smallest possible switching differential.

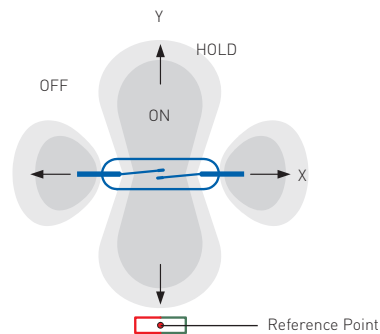

- 3 Switch operation by **rotation** of magnet. This gives two operations per complete rotation.

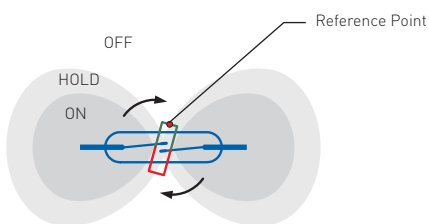

- 4 Operation of switch by **shielding**. This method requires a permanently opposite location of magnet and switch. The switch is held closed continuously and will release only if magnet flux is removed by means of ferro-magnetic shield.

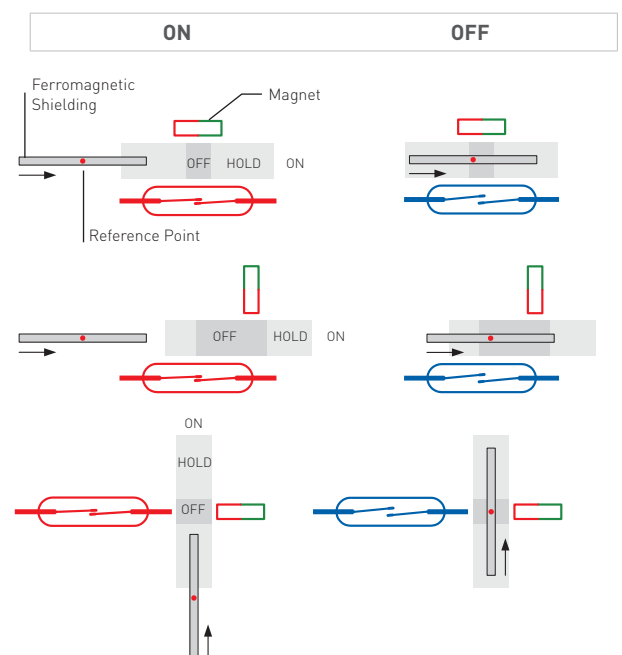

Check out our interactive  
Reed Switch here:  
[www.pic-gmbh.com/go](http://www.pic-gmbh.com/go)

# Reed Switches: Precautions

## Shock Resistance

Generally Reed Switches provide high shock resistance up to 100g. Still a drop on a hard surface can generate a shock of several 100g, which can lead to de-adjustment of contacts. Switches having been dropped should be re-tested for sensitivity before usage!

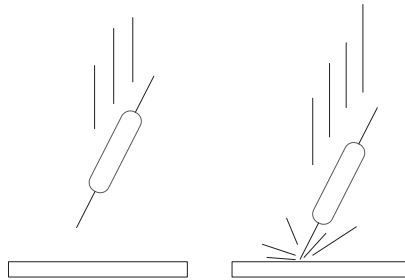

## Do's and Don'ts when cutting and bending Reed Switches

Incorrect bending or cutting of terminals may lead to cracks in the sealing area due to heavy mechanical stress. To avoid this problem the remaining part of terminal between glass body and point of bending resp. cutting, should be gripped tightly.

### Cutting

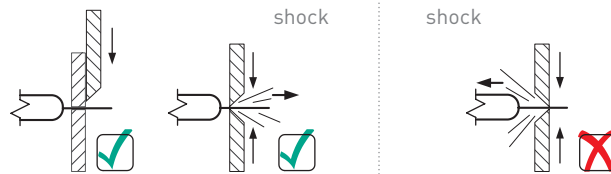

Forces directed away from Reed Switch

Forces directed toward Reed Switch!

### Bending

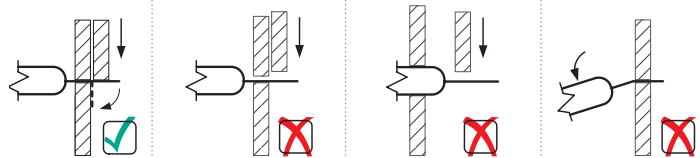

Terminal gripped tightly between glass body and point of bending

Terminal not gripped

Gripped on glass body

Terminal not gripped between glass body and point of bending

## Dimensioning of modified Reed Switches

We supply Reed Switches with terminals modified to nearly any requirement. Dimensioning should be made according to the examples below.

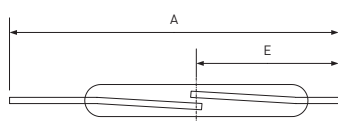

a) cut

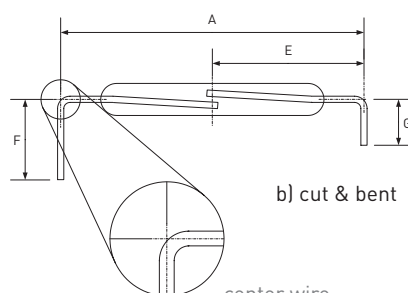

b) cut & bent

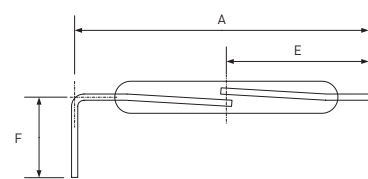

c) cut & bent

## Chemical resistance chart

+ = excellent o = limited - = poor	Chemical resistance @20° C/@60° C				
	ABS	PA	PP	POM	Stainless Steel 304
Acetic Acid, dilute	-/-	-/-	+/+	+/o	+/+
Acetone	-/-	+/+	+/o	+/o	+/+
Ammonium Hydroxide	o/-	+/+	+/+	+/+	+/+
Aniline	-/-	o/-	+/+	-/-	+/+
Beer, Wine, Whiskey	+/+	+/+	+/+	+/+	+/+
Butanol	+/o	+/+	+/+	+/o	+/+
Chloroform	-/-	-/-	-/-	-/-	+/+
Citric Acid	+/+	+/+	+/+	+/-	o/o
Copper Sulphate	+/+	-/-	+/+	+/+	o/o
Detergents	+/o	+/o	+/+	+/+	+/+
Diesel fuel	+/+	o/o	+/o	+/+	+/+
Ethanol	+/+	+/+	+/+	+/+	+/+
Ethylene Glycol	+/+	+/+	+/+	+/o	+/+
Ferric Chloride	+/+	-/-	+/+	-/-	-/-
Formaldehyde (Formalin)	+/+	o/o	+/+	+/+	+/+
Formic Acid	+/o	-/-	+/+	-/-	+/o
Fruit Juice	+/+	+/+	+/+	+/-	+/+
Gasoline	-/-	-/-	-/-	+/+	+/+
Glycerol (Glycerin)	+/+	+/+	+/+	+/+	+/+
Hydrochloric Acid	+/-	-/-	+/+	-/-	-/-
Hydrogen Peroxide, dilute	-/-	-/-	+/+	o/-	+/+
Lactic Acid	+/+	o/-	+/+	+/-	+/o
Methanol	-/-	o/-	+/+	+/+	+/+
Milk	+/o	+/+	+/+	+/+	+/+
Mineral Oil	+/+	+/+	+/+	+/+	+/+
Nitric Acid, dilute	-/-	-/-	+/+	-/-	+/o
Nitrobenzene	-/-	-/-	+/+	+/-	+/+
Phosphoric Acid, dilute	+/+	-/-	+/+	+/-	o/-
Propanol (IPA)	o/-	+/+	+/+	+/+	o/o
Silver Nitrate	+/o	o/-	+/+	+/-	+/+
Soaps	+/+	+/+	+/+	+/+	+/+
Sodium Hydroxide, dilute	+/+	o/-	+/+	+/+	+/+
Sulphuric Acid, dilute	o/-	-/-	+/+	o/-	o/-
Urine	+/+	+/+	+/+	+/+	+/+
Vegetable Oil	+/o	+/+	+/+	+/+	+/+
Water	+/+	+/o	+/+	+/+	+/+
Water, Sea-, Salt-	+/+	+/o	+/+	+/+	-/-

Above data is intended only as a guide for chemical compatibility.

We do not assume any liability for the accuracy of the information.

It is strongly recommended that users perform their own tests to determine suitability of material.

**Reed Switch based sensor technology on duty in a variety of industries and example applications. Contact us for individual solutions!**



#### White Goods

- Door control
- Flow sensing
- Condensate/water/detergent tank level
- Light/fan/alarm switches
- ...



#### Home Appliances

- Lid closure/position
- Water tank level
- Dip tray/waste water position and level
- Rounds per minute measuring for motors
- ...



#### Home Automation and Security

- Alarm systems door/window closure
- Garage doors/gate position
- Smoke detector activation
- Elevator systems position detection/door control
- ...

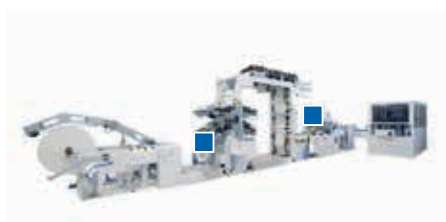

#### Industrial Applications

- Machine safety/gate control
- Lubricant/cooling aid/fluid tank level
- Cylinder/piston position control
- Material feeder monitoring
- ...



#### Sports Equipment

- Bicycle/E-Bike speed sensors
- Sensor actuating magnets
- Gym equipment speed measuring
- Brake detection
- ...



#### Measurement & Controls, Metering

- Gas/water metering counting switches
- Anti-temper detection
- Flow detection
- Current control
- ...

### Benefits

- /// Highly economic switching solution
- /// No supply current required
- /// Non-touch switching – no physical contact needed
- /// Long operation/life time
- /// Food contact suitable materials
- /// Resistant against ESD, dirt, corrosion and humidity

